

collection  
2024

HIMA





Partner van:



## MODERN

ABONI .....	9
ACAPUL .....	11
ADAGIO .....	13
ASOLO .....	15
BOLIDE .....	17
BOGOTA .....	19
CETINJE .....	21
CODAN .....	23
COME .....	25
CORIA .....	27
CULEBRA .....	29
DALVIK .....	31
DERUTA .....	35
KENTANI .....	37
MECU .....	39
MORALES .....	41
OVALLE .....	43
PAUNO .....	45
RIBBA .....	47
RUSH .....	49
SELFOSS .....	51
SEPLAN .....	53
UXMAL .....	55
VALDIVA .....	57
YONDO .....	59
ZENIKA .....	61

## DECO

ANDES .....	65
ANGOLA .....	67
BELIN .....	68
COCOON .....	69
BRETON .....	71
CARLA .....	75
CASALE .....	77
DIMBARA .....	79
DONITA .....	81
FORSA .....	83
FRONTINO .....	85
GLENN .....	87
GRANO .....	89/92
GREYTON .....	91
KOTOR .....	93
LIAM .....	97
MAEVE .....	99
MAGNOLA .....	101
MARLON .....	103
MELODIE .....	107
MOIANO .....	109
MONO .....	111
MONTONE .....	113
MUMBAI .....	115
MUSK .....	117
NUBE .....	118
PENELOPE .....	119
PLUMI .....	122
POLANY .....	123
SALTILLO .....	125
SCALA .....	129
SILANUS .....	131
SQUARE .....	133
ST GERMAIN .....	135
TSOMO .....	137

## CLASSIC

ALICIA .....	141
ANAIS .....	143
BALCONY .....	145
CHIVOR .....	147
DRESDEN .....	149
ELYSEE .....	151
GIORGIA .....	153
GISSI .....	155
LORE .....	157
MANDY .....	159
MARTHA .....	161
MERLOT .....	163
MINEROS .....	165
ORTONA .....	167
PANENKA .....	169
PAUL .....	171
SANDY .....	173
SORSO .....	175
THARA .....	177
THORGAL .....	179
TREK .....	181

## EXCLUSIVE

ADAGIO .....	185
ALPES .....	187
ANDES .....	189
ANDREAS .....	191
AZUMA .....	193
BIBONA .....	195
CALDAS .....	197
CELANO .....	199
CHIVOR .....	201
CODAN .....	203
COME .....	205
ELSY .....	207
LORE .....	209
MANDY .....	211
MERLOT .....	213
MODRIC .....	215
NOUPOINT .....	217
ORTONA .....	219
PANENKA .....	221
ROSARO .....	223
SANDY .....	225
SERPA .....	227
THEO .....	229
UMITI .....	233
WILSON .....	235

## ACCESSORIES

BOB/BOBETTE .....	236
BARBI .....	236
GERARD/GERALDINE .....	236
SANDER/SANDRINE .....	236
BASSO/BALOR .....	237
CALI/CALINE .....	237
IKER .....	237
ITALY .....	238
NORDIK .....	238
PIRAS .....	238
PLUMI .....	239
TAMBER .....	239
TAMPICO .....	239
LAZE .....	240
FAN 1/2/10/14/23/30/31/35/ 60/130 .....	241

# Nettoyer uniquement a l'eau



  
*Easy to Clean*  
only with water

  
aqua  
clean<sup>®</sup>  
TECHNOLOGY

  
H<sup>2</sup>O<sup>h</sup>  
just with water

## 3 technologies: 1 solution

- Traitement révolutionnaire qui permet d'enlever les taches en utilisant **simplement un peu d'eau**
- Ce traitement permet de **supprimer les tâches** domestiques, tels que le cafés, l'encre, chocolat, vin, etc...
- Ce **traitement recouvre chaque fibre** d'une couche moléculaire invisible qui évite que la saleté pénètre dans le tissu.



1. Retirez l'excès du produit causant la tache sur le tissu (dans le cas d'une tache d'encre, gommer avec un tissu sec.)



2. Humidifiez légèrement la tache, soit en versant un peu d'eau directement dessus, soit à l'aide d'un chiffon propre et humide. Attendre quelques secondes.

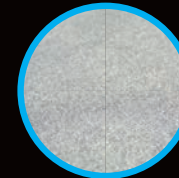

3. Appuyez sur la tache à l'aide d'un chiffon propre puis effacez-la en réalisant des petits cercles jusqu'à disparition de celle-ci.

# Reinigen enkel met water

## 3 technologieën : 1 oplossing

- Revolutionaire behandeling die toelaat om vlekken eenvoudig te verwijderen **enkel met water**.
- Behandeling die toelaat om **vlekken** zoals koffie, inkt, chocolade, wijn,... te **verwijderen**.
- Deze **behandeling voorziet elke vezel** van een moleculaire, onzichtbare laag die verhindert dat het vuil de stof indringt.



1. Verwijder het overtollig residu dat op de bekleding is gegoten.



2. Breng water aan op de vlek. Rechtstreeks of met een absorberende, vochtige en uitgewrongen doek. Wacht een paar seconden.

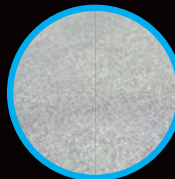

3. Druk met een doek op de vlek en wrijf zachtjes over de bekleding met rondgaande bewegingen. Als de vlek niet helemaal verdwijnt, herhaal dan het proces zo vaak als nodig.

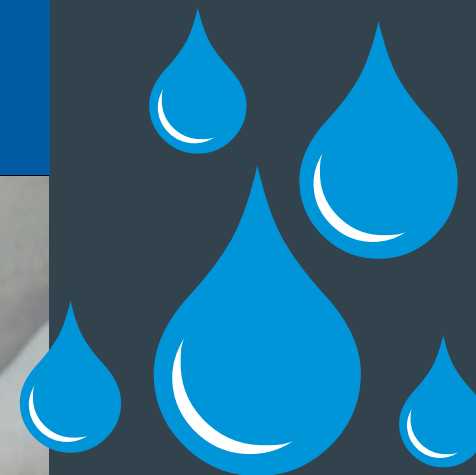

  
*Easy to Clean*  
only with water

**aqua  
clean**<sup>®</sup>  
TECHNOLOGY

  
**H<sup>2</sup>O<sub>h</sub>**  
just with water





MODERN

MODERN

## VAST / FIXE

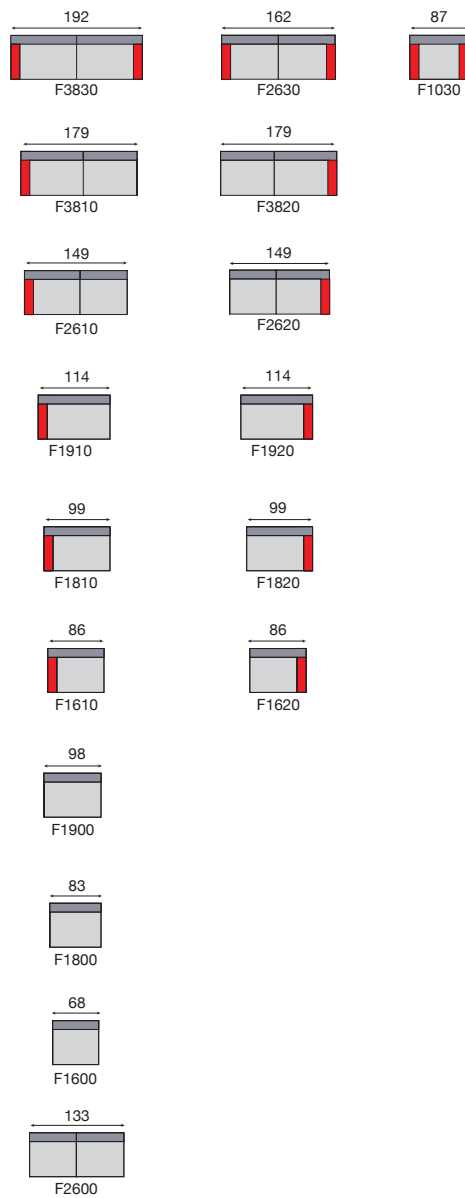

## RELAX ELEKTRISCH / ELECTRIQUE

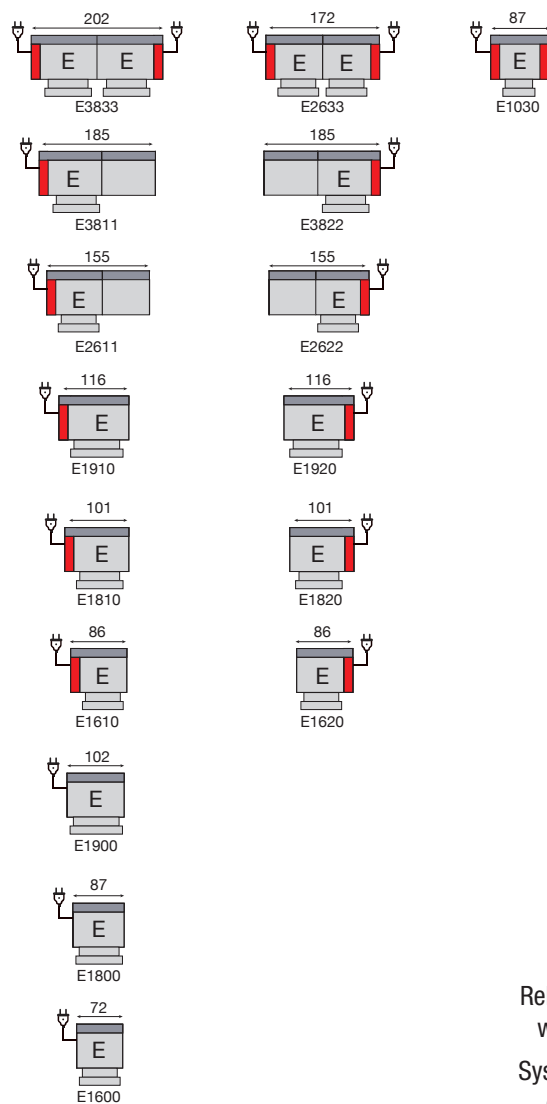

Relaxsystem  
wall-away  
Système relax  
dos-mur

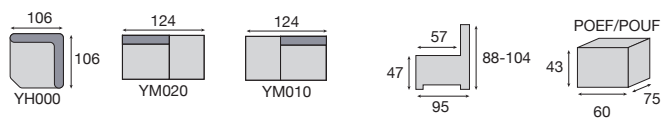
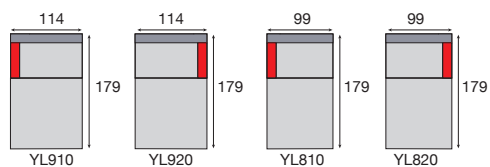



# ABONI



E3833+F2630 • Barmon Coconut  
2 x Fan31 Barmon Mustard

ABONI = toon op toon  
= fil ton sur ton

MODERN

## VAST / FIXE

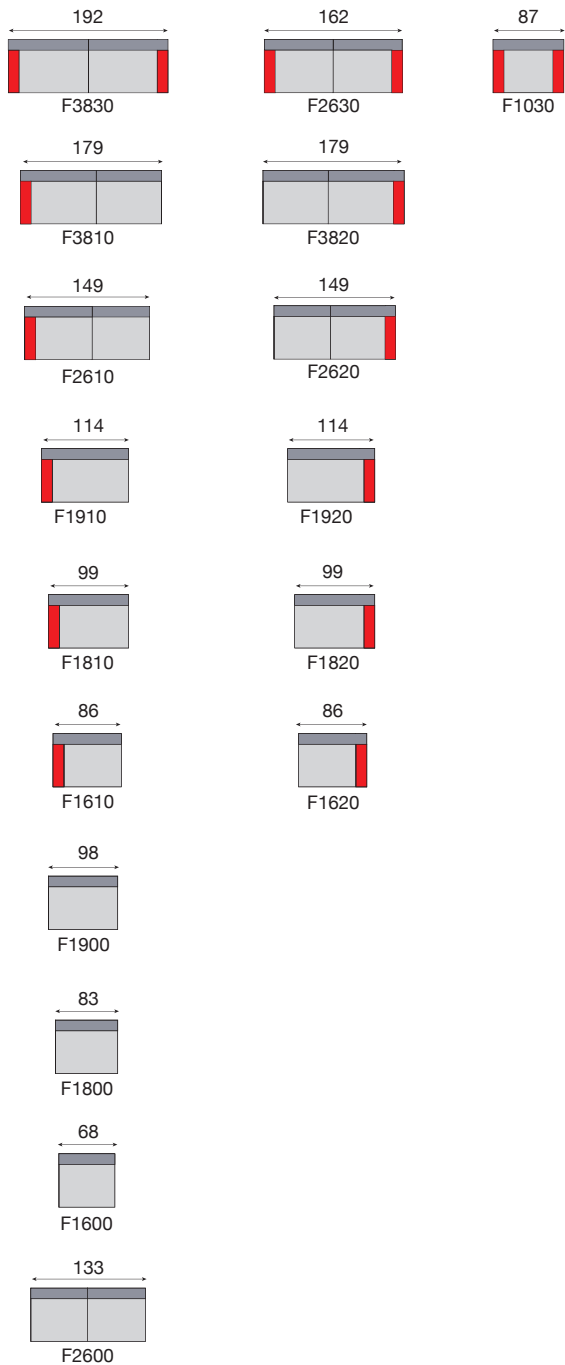

## RELAX ELEKTRISCH / ELECTRIQUE

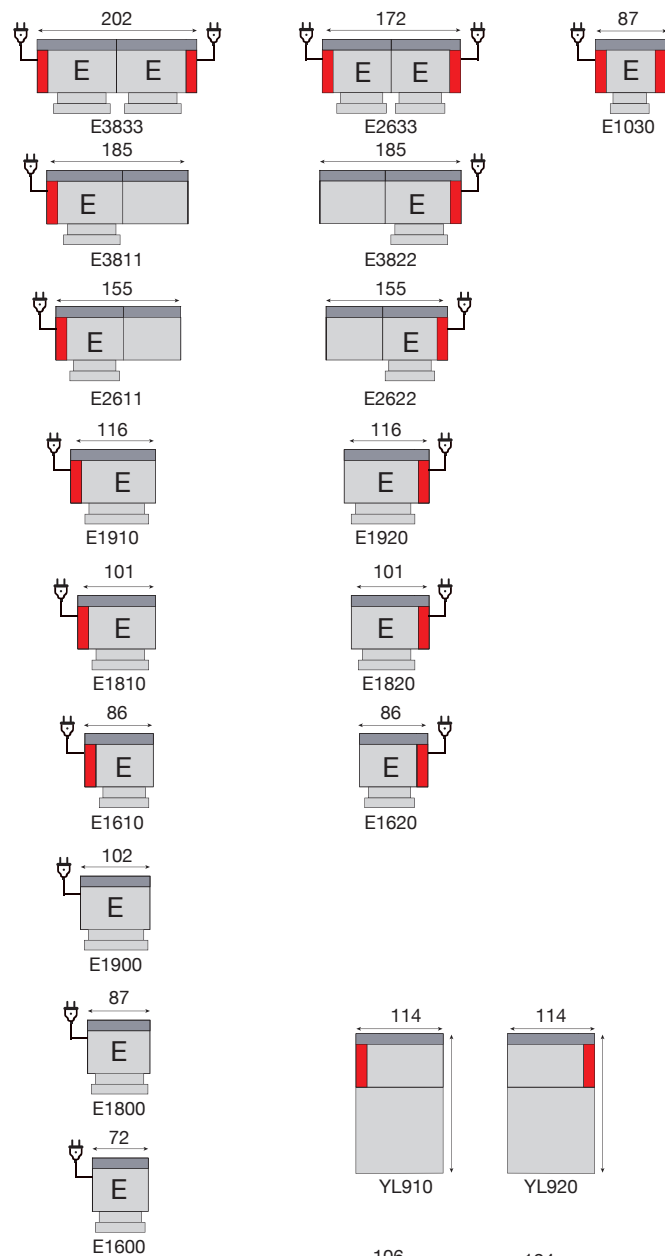

# ACAPUL

Relaxsystem  
wall-away  
Système relax  
dos-mur

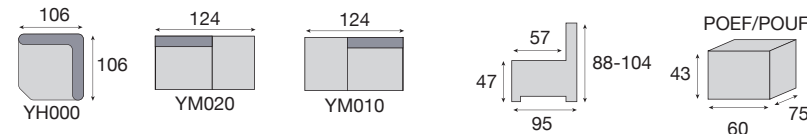
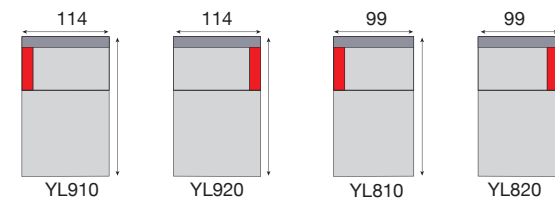

# ACAPUL

MODERN



F2630+E1910+YL920 • Batch Mustard  
2 x Fan31 Bador Gold

ACAPUL = toon op toon  
= fil ton sur ton

## VAST/FIXE

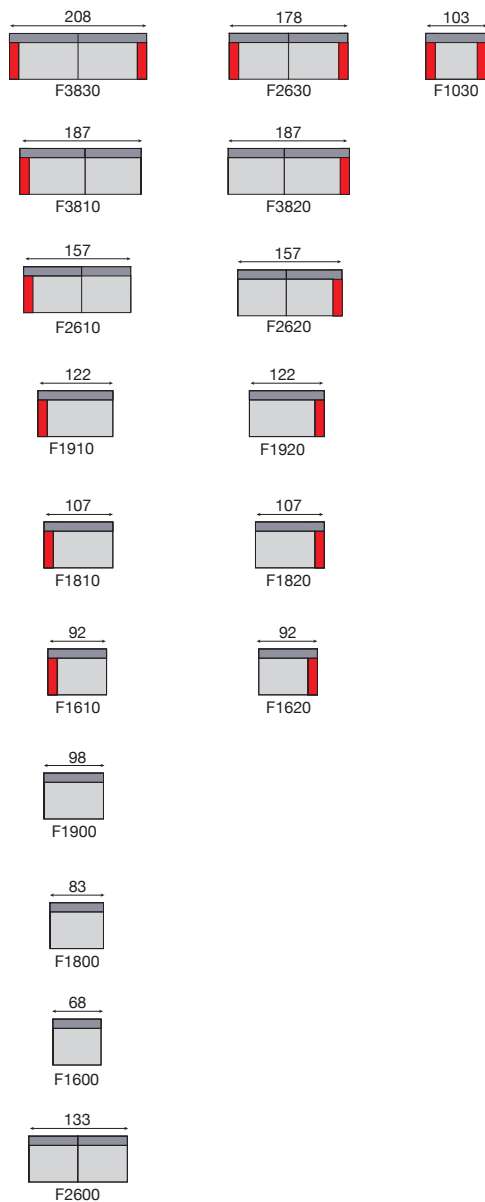

## RELAX ELEKTRISCH/ELECTRIQUE

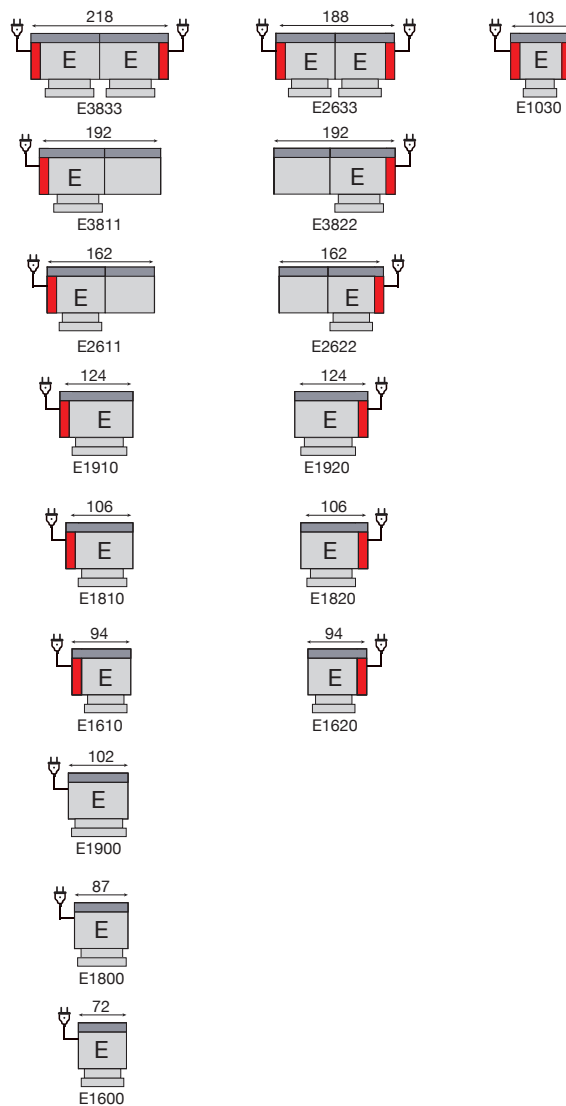

# ADAGIO

Relaxsystem  
wall-away  
Système relax  
dos-mur

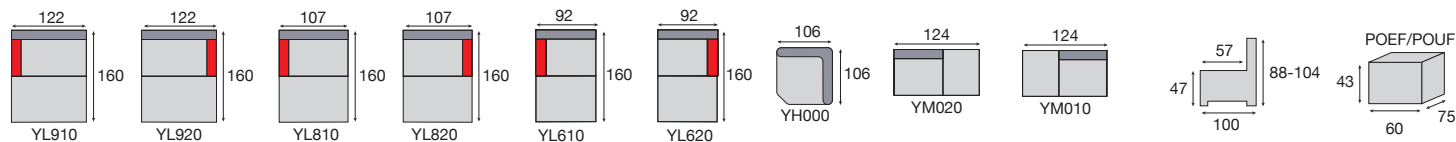

# ADAGIO



MODERN

E3833+F2630 • Bepal Chocolat

2 x Fan31 Bicti Cathay Spice

1 x Fan31 Bador Hazel

ADAGIO = toon op toon  
= fil ton sur ton

ADAMO = contrasterend garen  
= fil contrasté



## VAST/FIXE

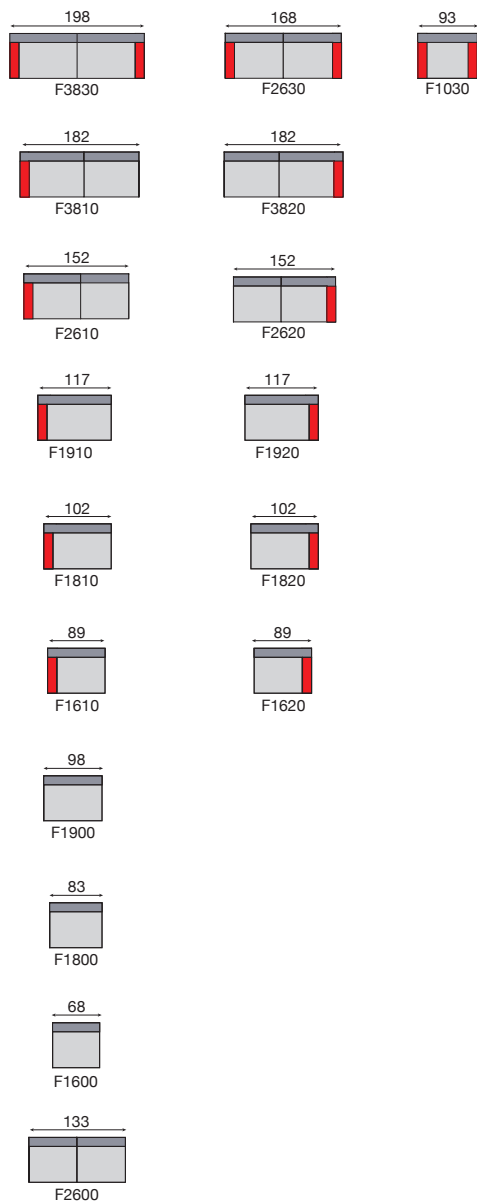

## RELAX ELEKTRISCH/ELECTRIQUE

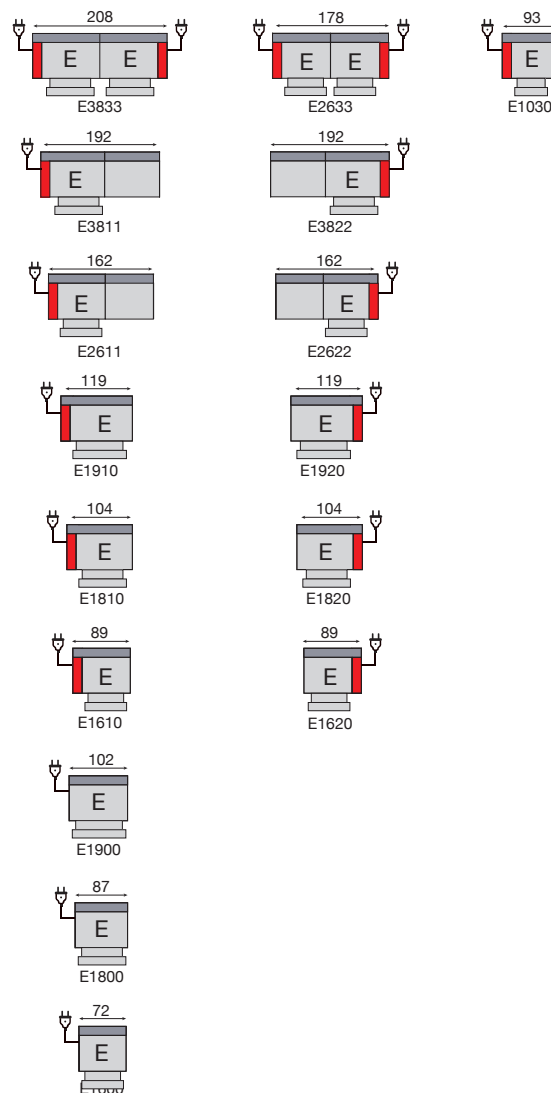

# ASOLO

Relaxsystem  
wall-away  
Système relax  
dos-mur

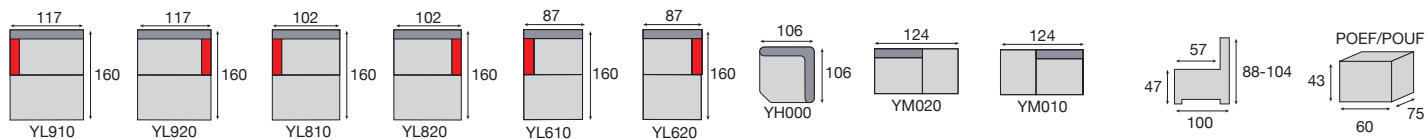

# ASOLO



TAMPICO Club  
Cout Bronze



MODERN

YL910+E3822  
Bicti Cathay Spice

ASOLO = toon op toon  
= fil ton sur ton





F3830+F2630 • Sisso Brown

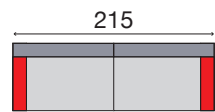

F3830

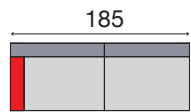

F3810

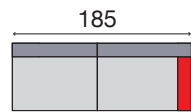

F3820

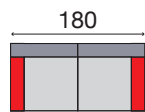

F2630

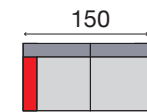

F2610

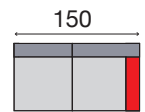

F2620

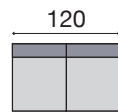

F2600

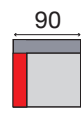

F1610

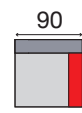

F1620

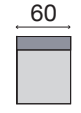

F1600

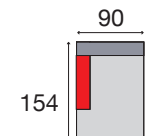

YL610

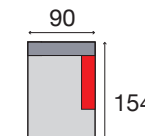

YL620

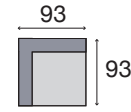

YH000

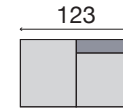

YM010

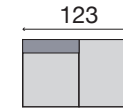

YM020

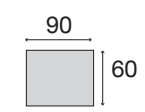

YP000

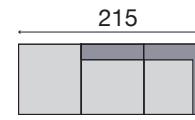

YTT010

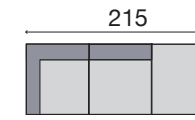

YTT020

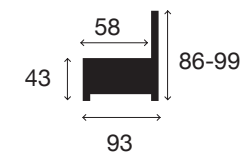



# BOLIDE



BALOR Club  
Bador Hazel

YTT010+F3820 • Ston Cognac  
3 x Fan31 Bador Hazel

BITCO = toon op toon  
= fil ton sur ton

BOLIDE = contrasterend garen  
= fil contrasté

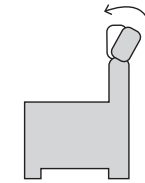
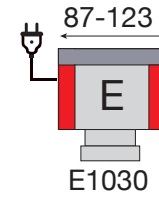
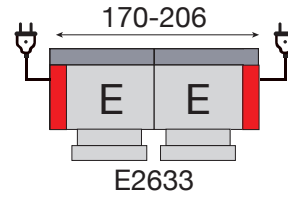
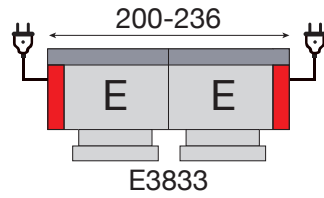
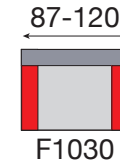
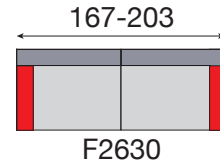
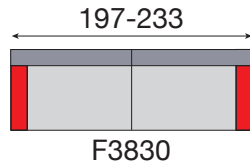

Manuele hoofdsteun  
Appui-têtes manuelles  
(codes E)

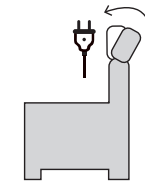
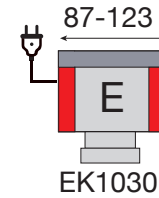
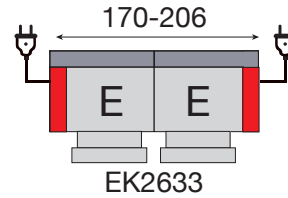
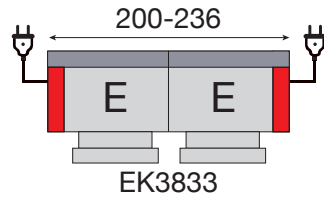

Elektrische hoofdsteun  
Appui-têtes électriques  
(codes EK)

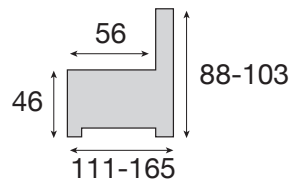

Relaxstelsysteem  
wall-away  
Système relax  
dos-mur

# BOGOTA



EK3833+F2630 • Saven Beige  
2 x Fan31 Bador Darkgrey

BOGOTA= toon op toon  
= fil ton sur ton

MODERN

## VAST / FIXE

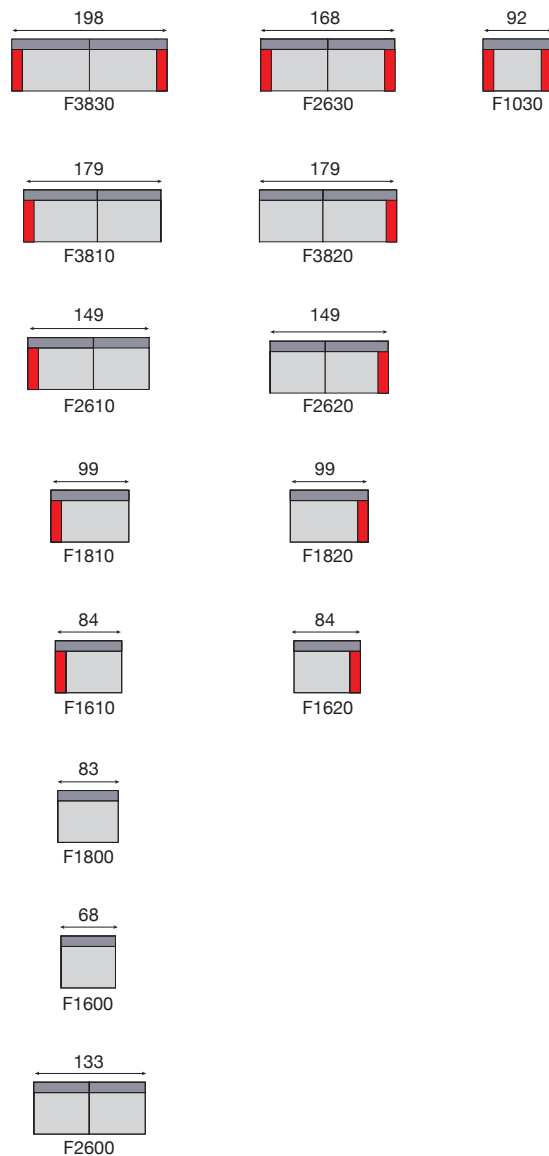

## RELAX ELEKTRISCH / ELECTRIQUE

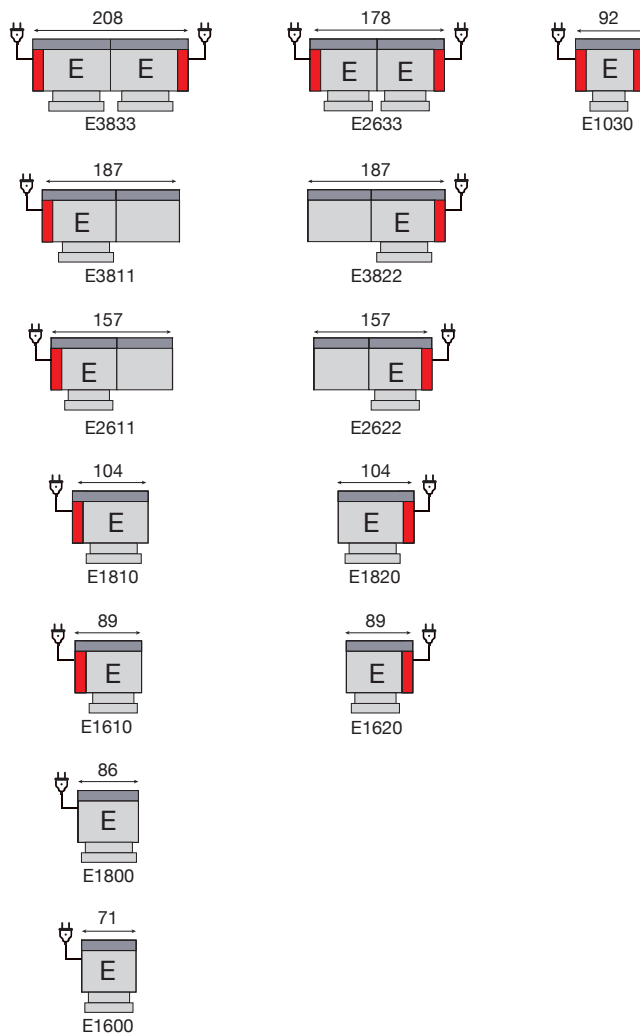

## CETINJE

Relaxsystem  
wall-away  
Système relax  
dos-mur

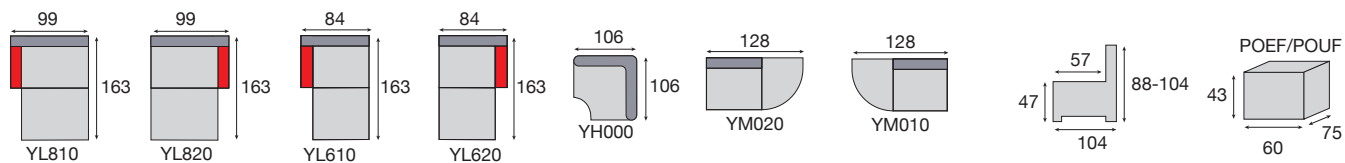

# CETINJE



MODERN

E3811+YH000+YM020 • Topic Nero  
2 x Fan31 Storza Dove

CETINJE = toon op toon  
= fil ton sur ton

## VAST/FIXE

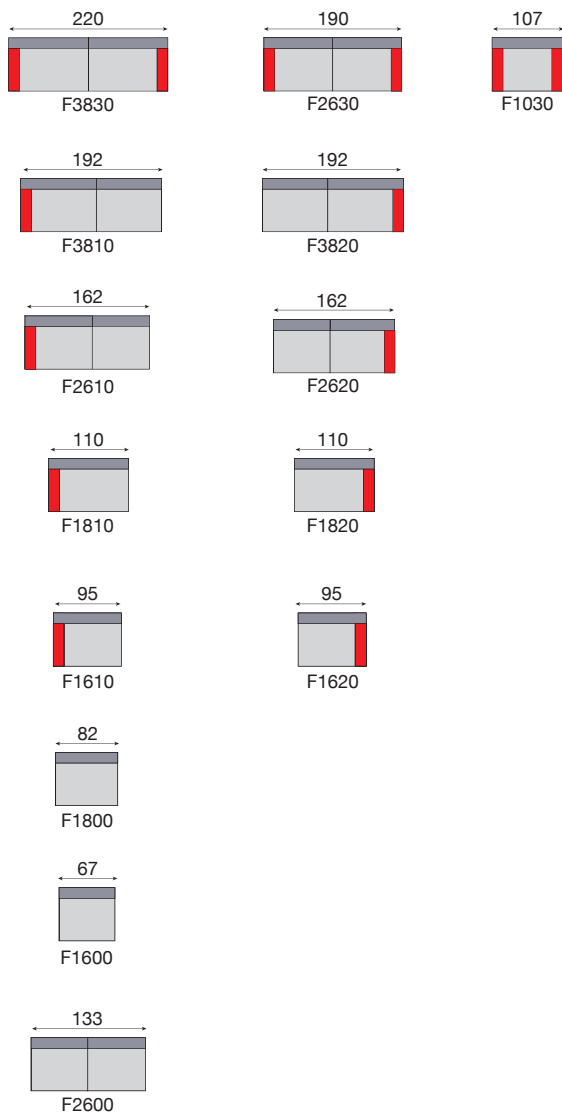

## RELAX ELEKTRISCH/ELECTRIQUE

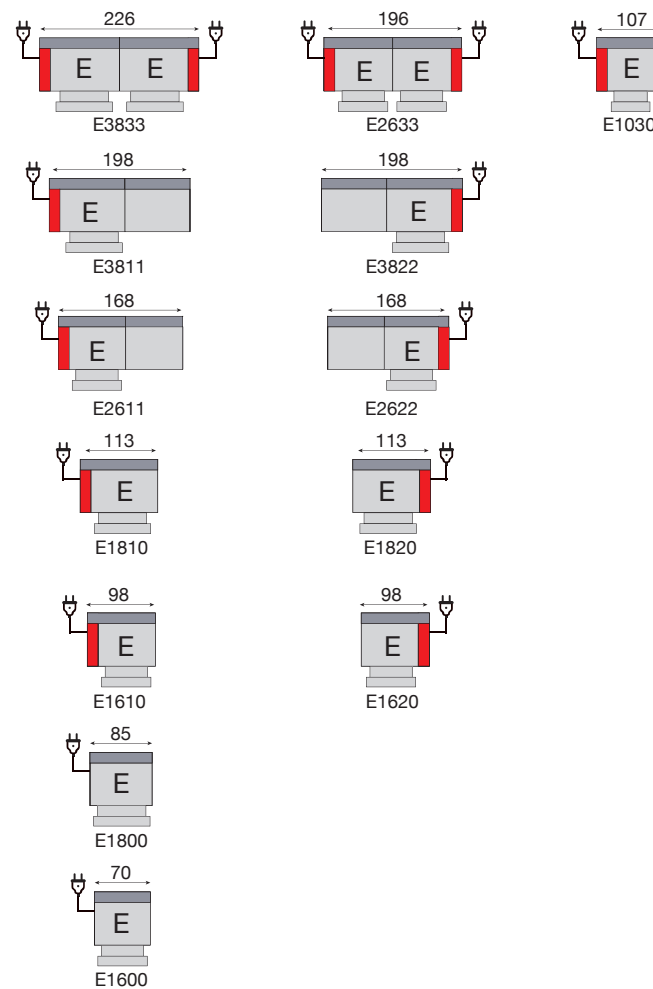

Relaxsystem  
wall-away  
Système relax  
dos-mur

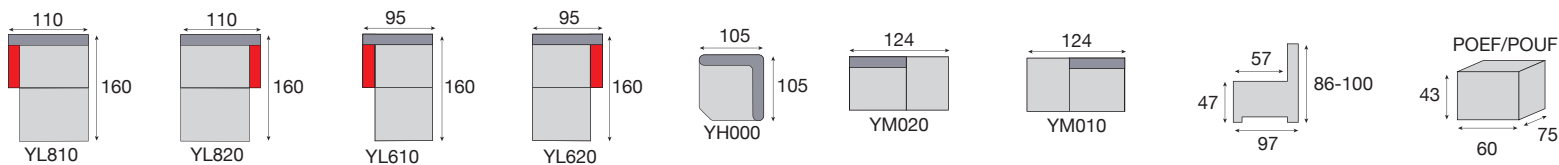

# CODAN



E3833+F2630 • Berib Salmon/CF100  
3 x Fan30 Abron Ash

CODAN = toon op toon  
= fil ton sur ton

CANYON = contrasterend garen  
= fil contrasté



## VAST/FIXE

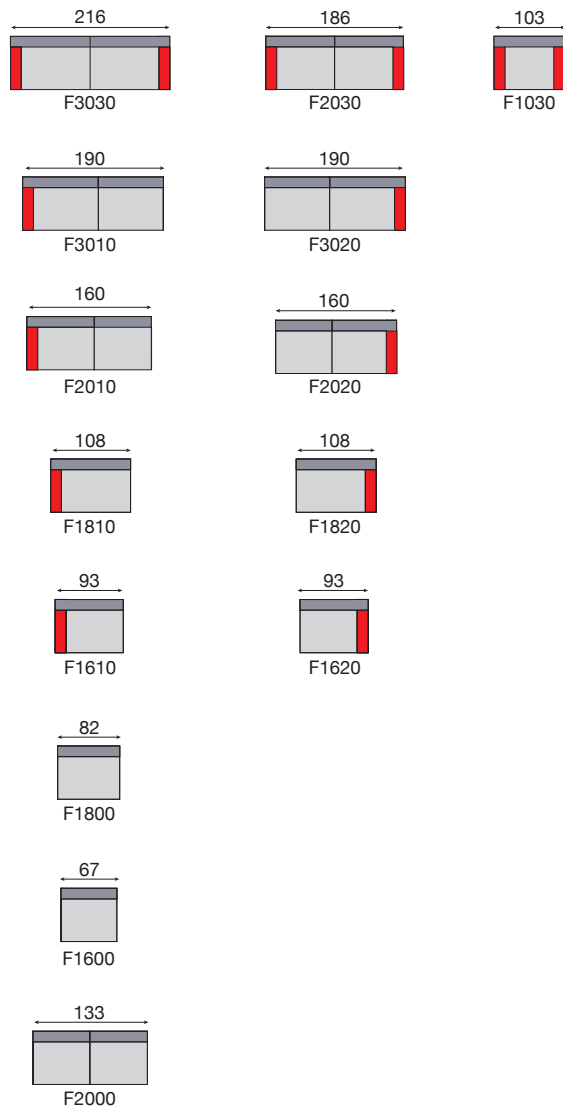

## RELAX ELEKTRISCH/ELECTRIQUE

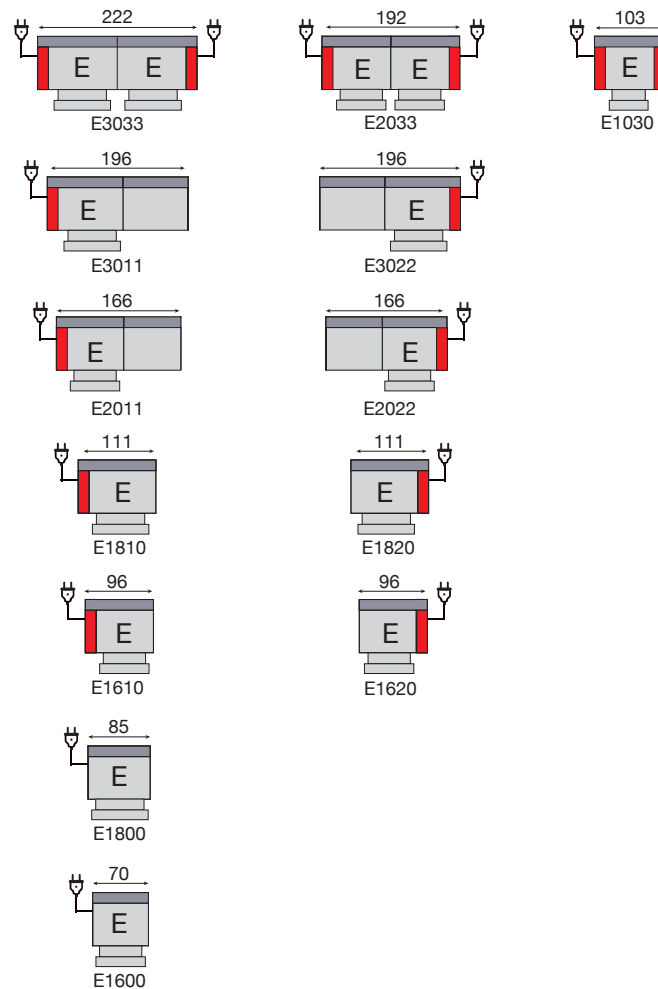

Relaxsystem  
wall-away  
Système relax  
dos-mur

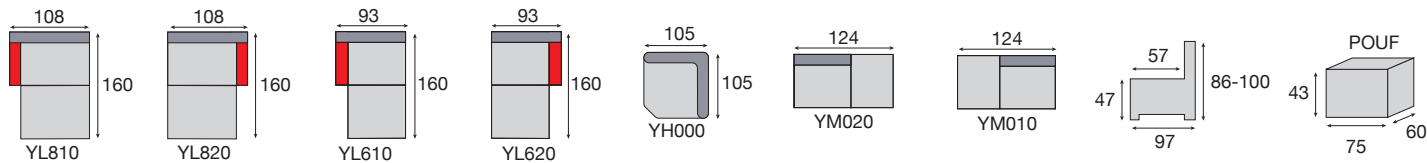



# COME



YM010+YH000+E1800+E1820 • Ago Antraciet/CF100  
2 x Fan30 Ago Silver



COME = toon op toon  
= fil ton sur ton

CONDOR= contrasterend garen  
= fil contrasté

25

MODERN

## VAST / FIXE

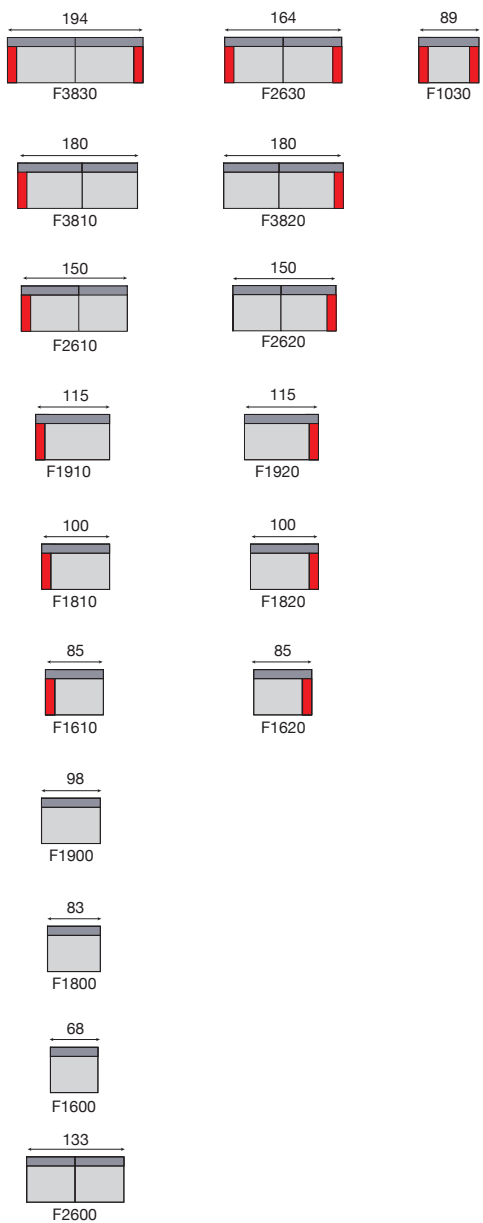

## RELAX ELEKTRISCH / ELECTRIQUE

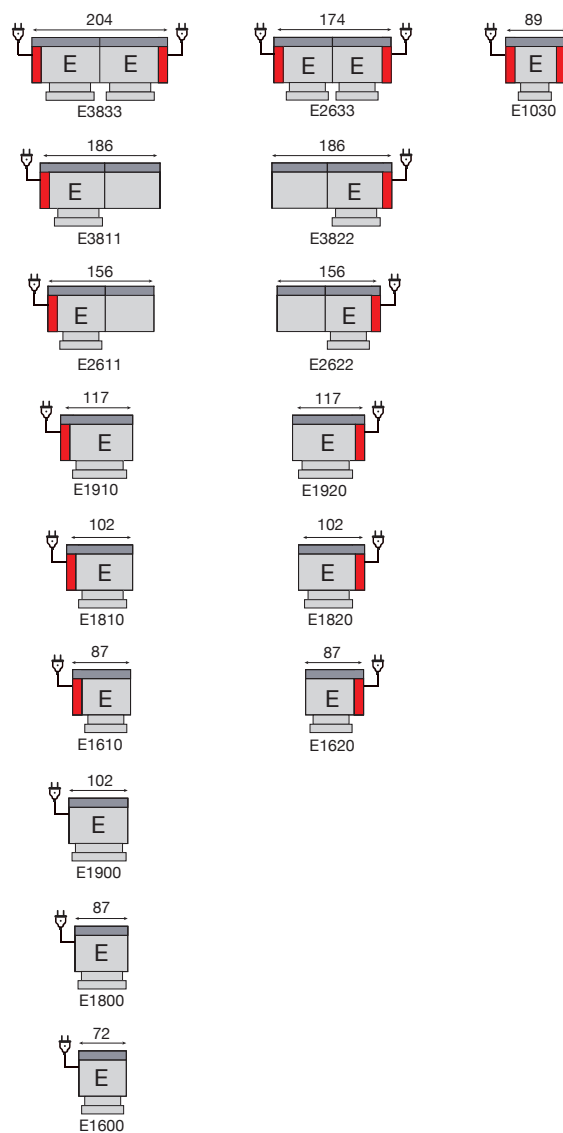

# CORIA

Relaxsystem  
wall-away  
Système relax  
dos-mur

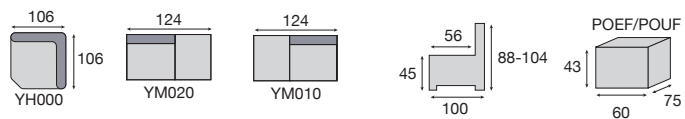
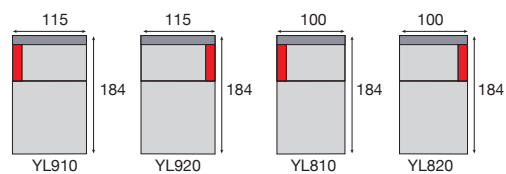

# CORIA

MODERN



F2630+E1910+YL920 • Beskin Elephant  
2 x Fan31 Bitoli Celadon

## VAST / FIXE

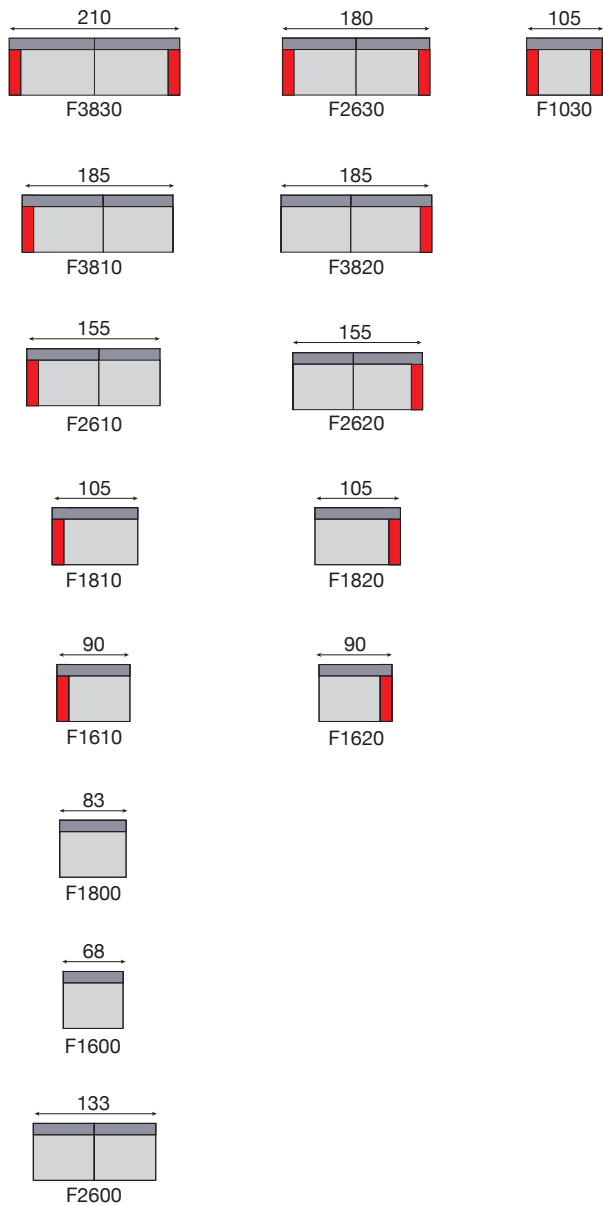

## RELAX ELEKTRISCH / ELECTRIQUE

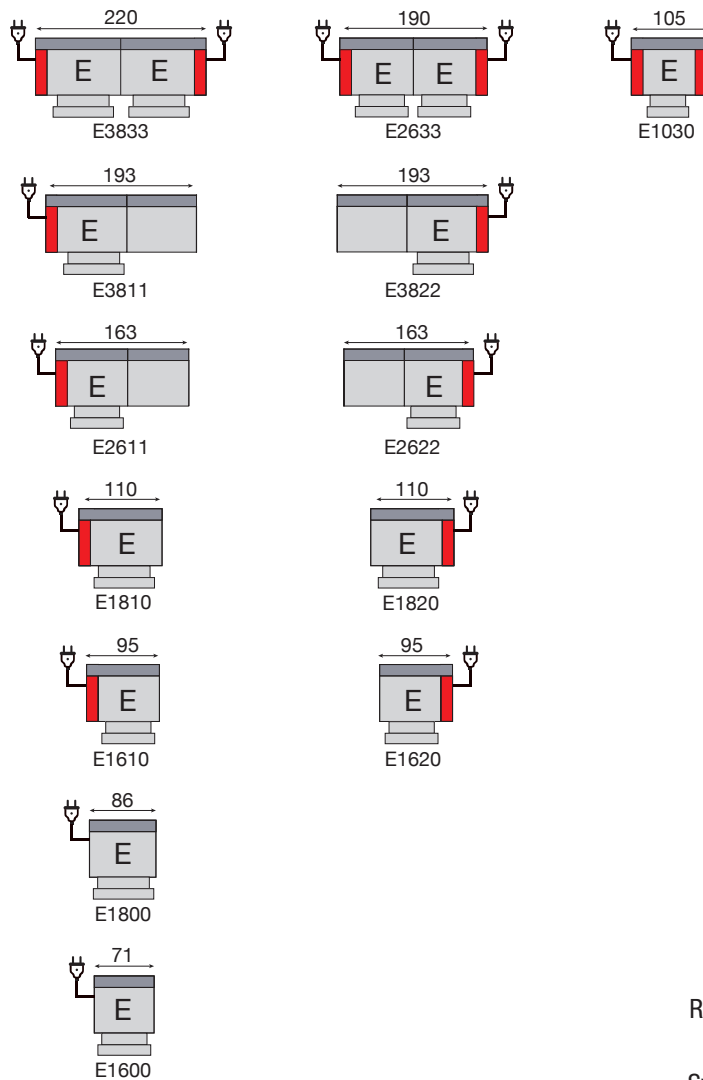

## CULEBRA

Relaxsystem  
wall-away  
Système relax  
dos-mur

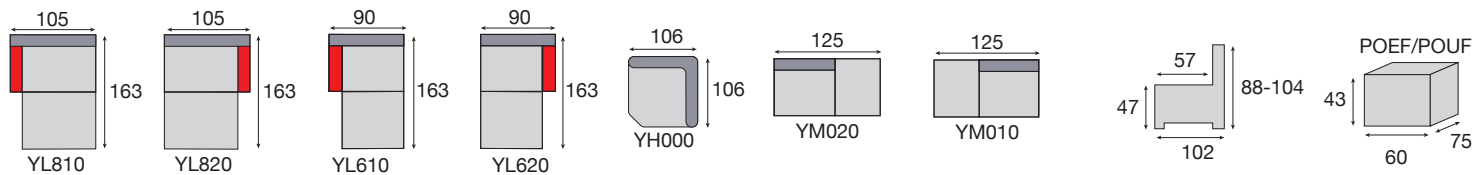

# CULEBRA



MODERN

E3833+F2630 • Beak Natural  
2 x Fan31 Aris Black

CULEBRA = toon op toon  
= fil ton sur ton

CUBALIBRE = contrasterend garen  
= fil contrasté

# CULEBRA



Afmetingen zie p. 28  
Dimensions p. 28

F3830+YH000+YM020 • Bannel Blue

30

  
H<sup>2</sup>Oh  
just with water

CULEBRA = toon op toon  
= fil ton sur ton

CUBALIBRE = contrasterend garen  
= fil contrasté

# DALVIK



MODERN

Afmetingen zie p. 32  
Dimensions p. 32

E3833+F2630  
Bitoli Blue

DALVIK = toon op toon  
= fil ton sur ton

## VAST / FIXE

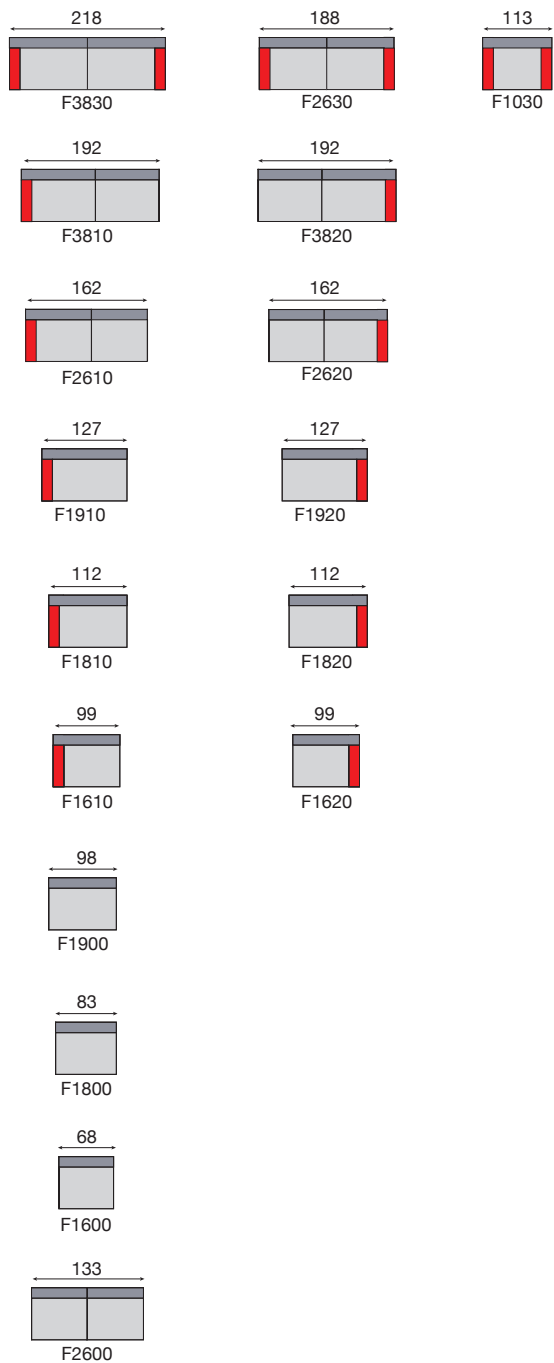

## RELAX ELEKTRISCH / ELECTRIQUE

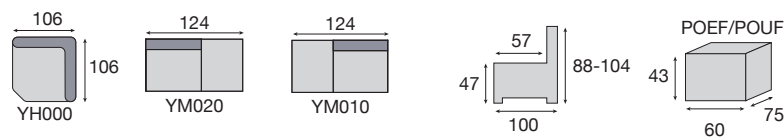
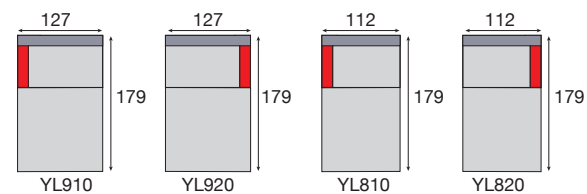
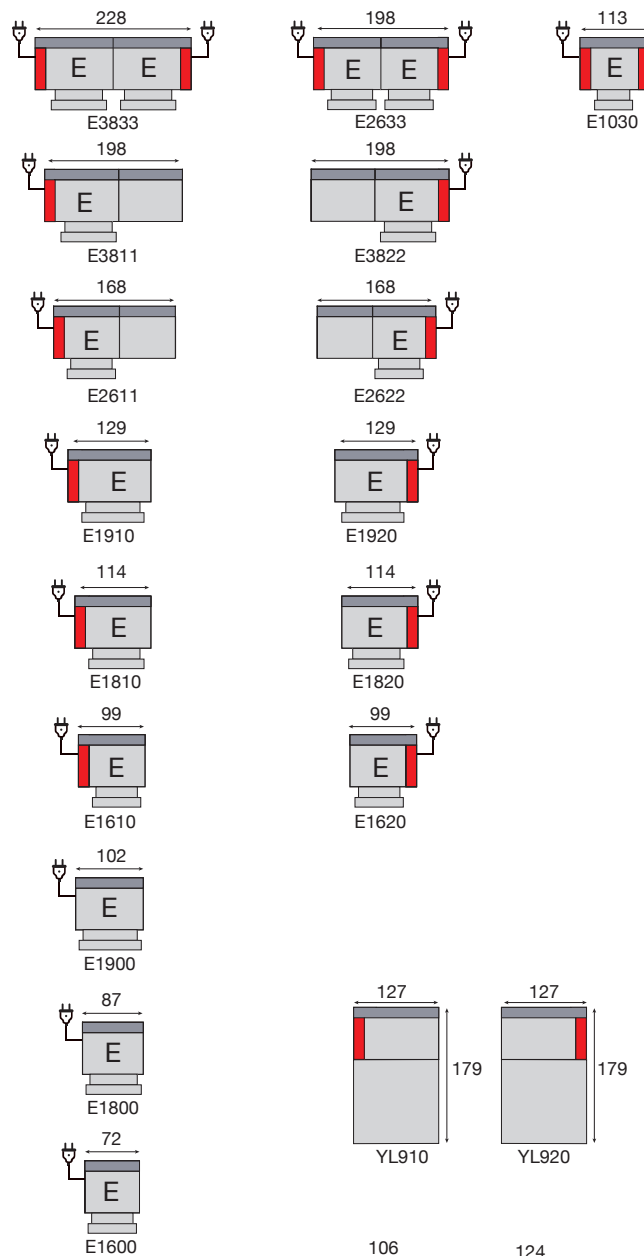

Relaxsystem  
 wall-away  
 Système relax  
 dos-mur



# DALVIK



MODERN

YL910+E1800+E1800+YH000+F2630  
Bepal Lightgrey

DALVIK = toon op toon  
= fil ton sur ton

## VAST/FIXE

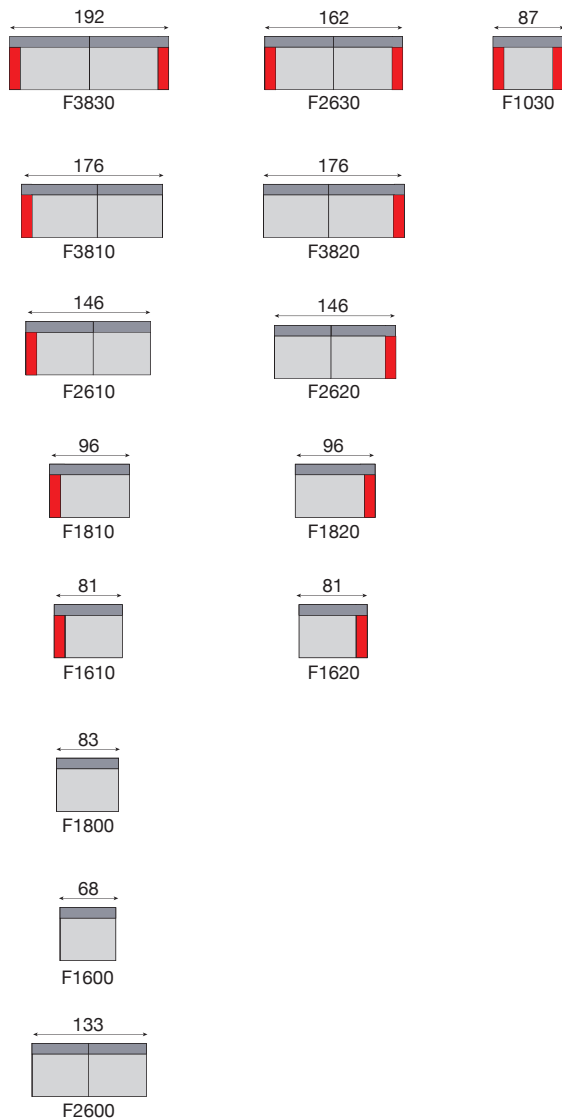

## RELAX ELEKTRISCH/ELECTRIQUE

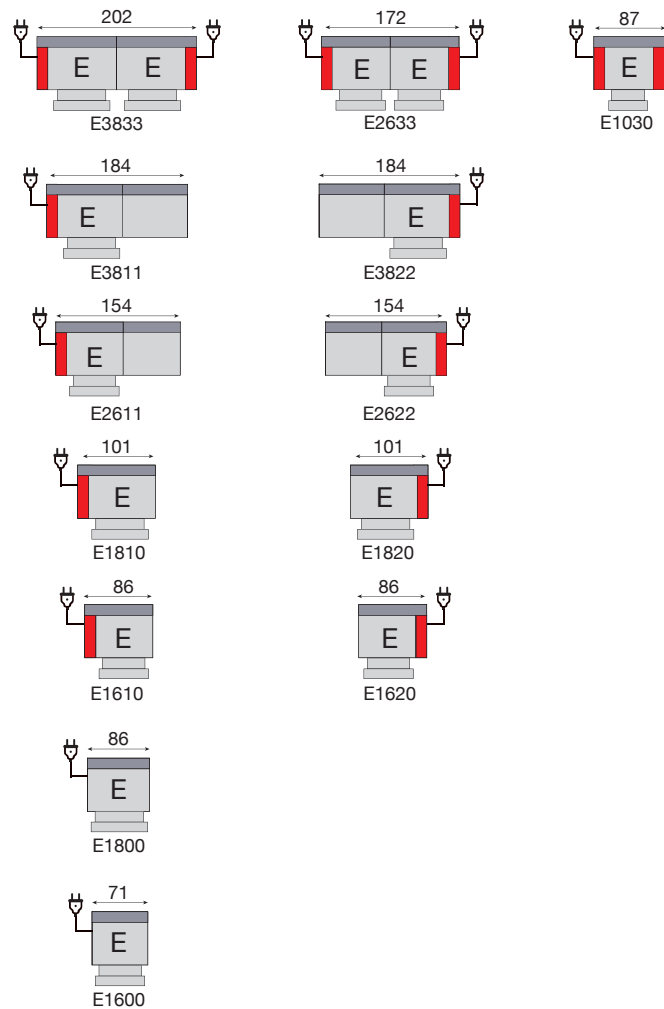

Relaxsystem  
 wall-away  
 Système relax  
 dos-mur

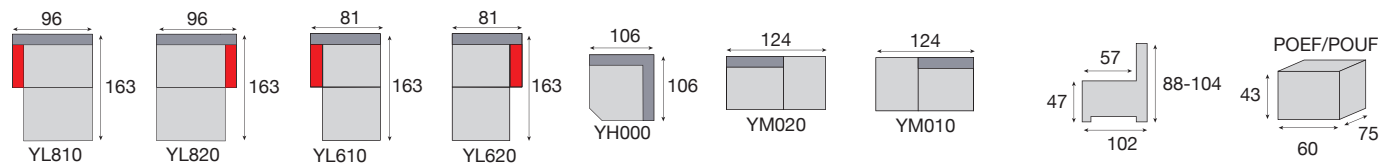

# DERUTA



RONDO Club  
Berib Earth

E3811+YL820 • Bador Darkgrey

2 x Fan31 Berib Earth

2 x Fan31 Bador Darkgrey

DIMANO = toon op toon  
= fil ton sur ton

DERUTA = contrasterend garen  
= fil contrasté

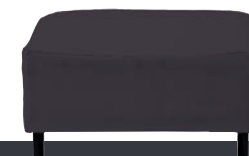

## VAST / FIXE

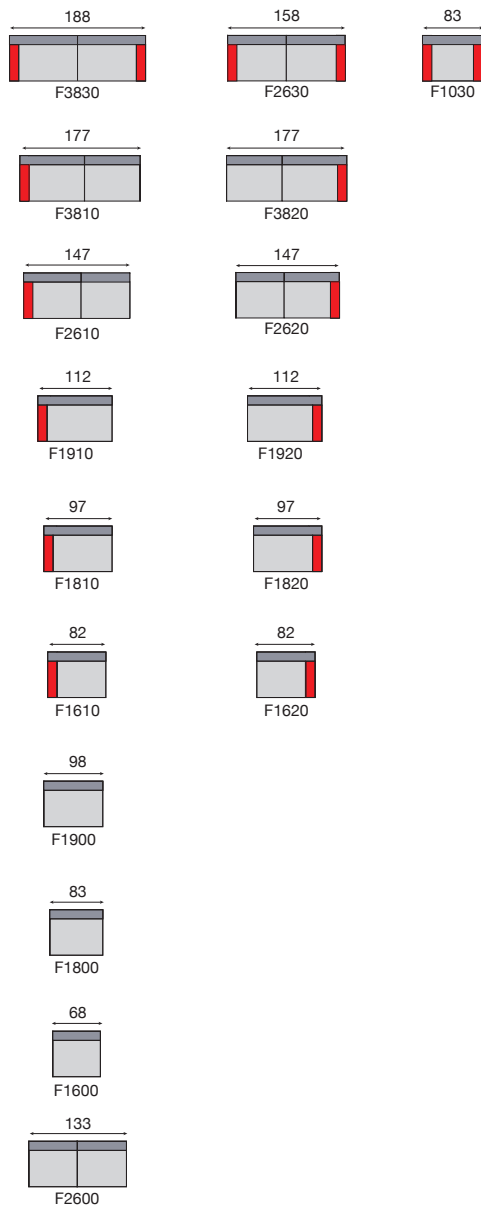

## RELAX ELEKTRISCH / ELECTRIQUE

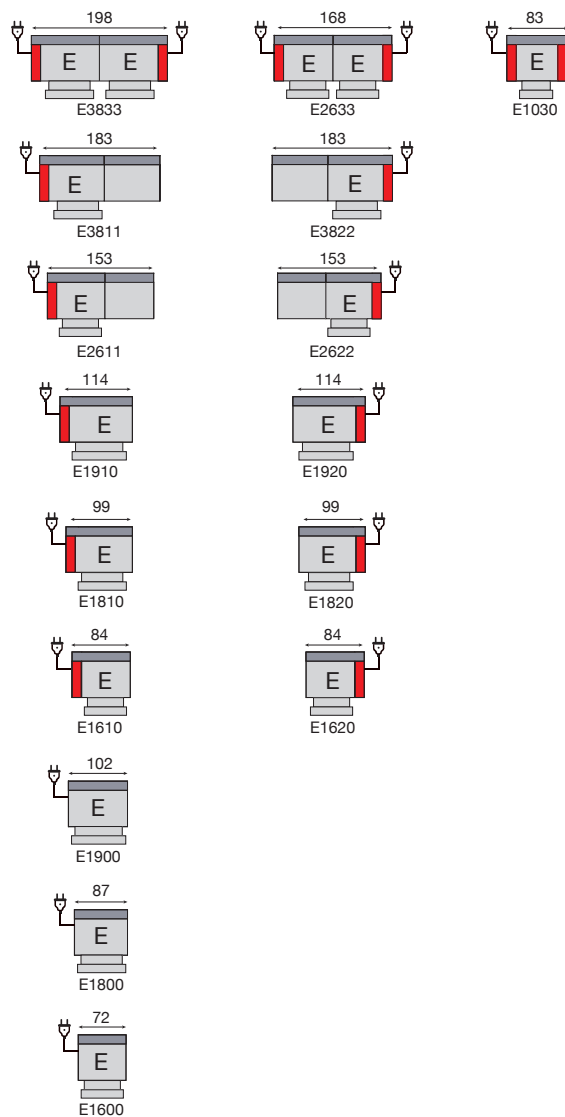

## KENTANI

Relaxsystem  
wall-away  
Système relax  
dos-mur

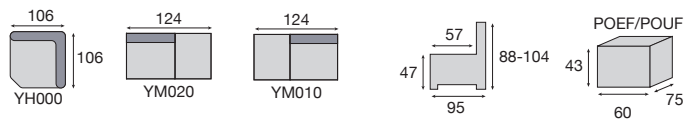
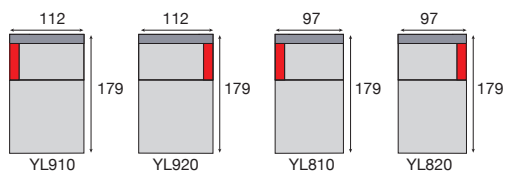

# KENTANI



YL910+E1800+E1800+YH000+F3820 • Bepal Grey  
2 x Fan31 Batch Taupe

KENTANI = toon op toon  
= fil ton sur ton

## VAST/FIXE

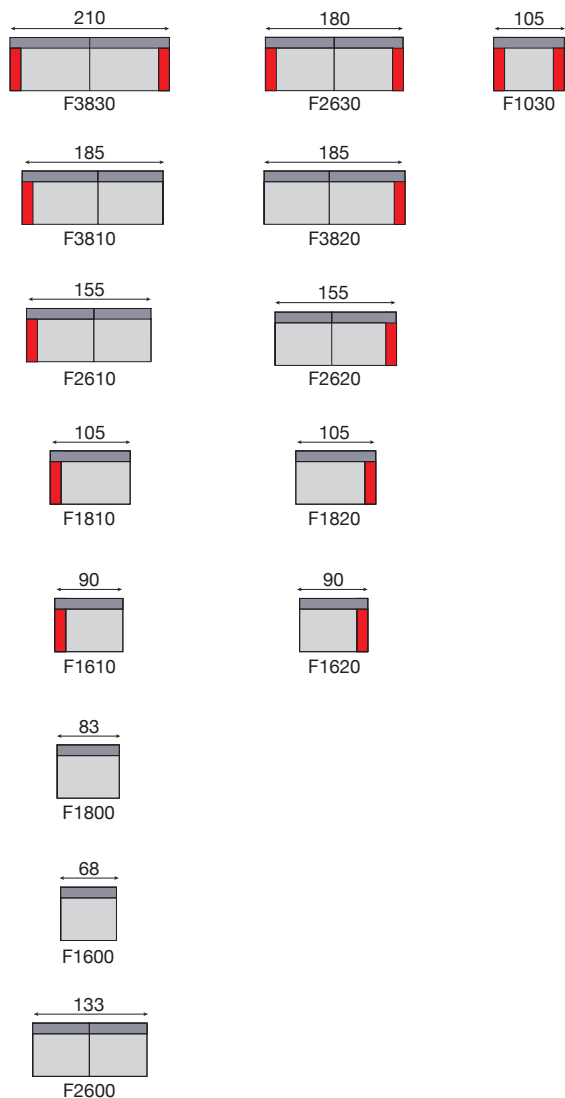

## RELAX ELEKTRISCH/ELECTRIQUE

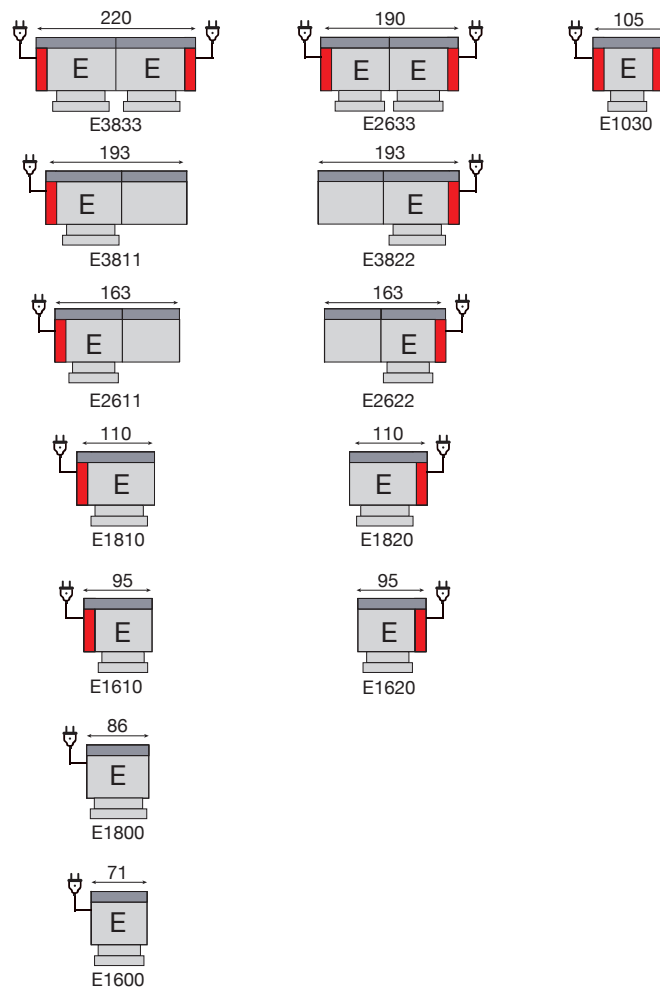

Relaxsystem  
wall-away  
Système relax  
dos-mur

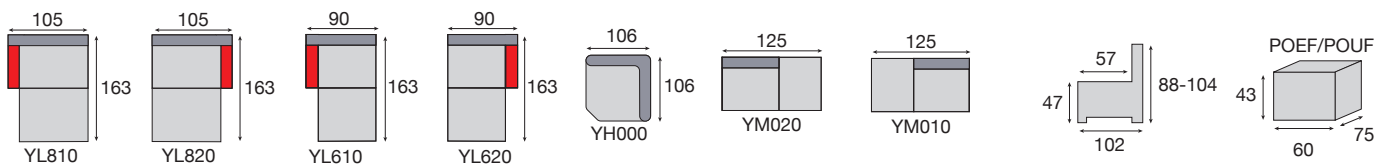

# MECU



poef Jacques/  
Jacqueline  
Bicas Sand

E3833+F2630 • Bicas Sand  
4 x Fan 31 Aris Black

MEZDI = toon op toon  
= fil ton sur ton

MECU = contrasterend garen  
= fil contrasté



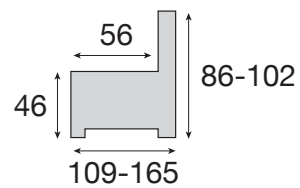
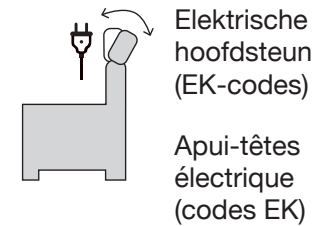
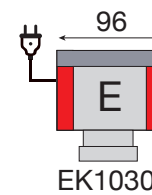
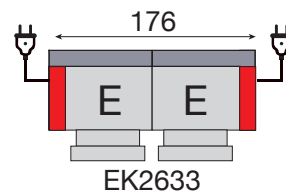
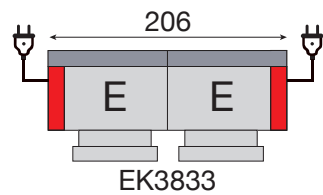
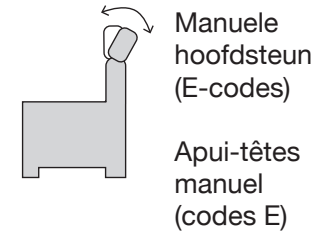
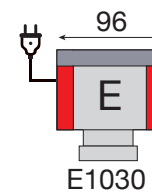
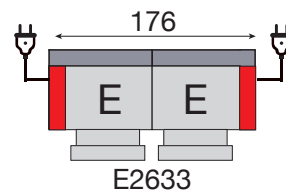
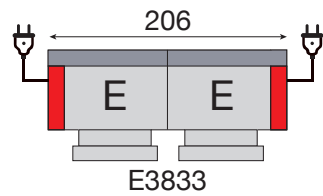
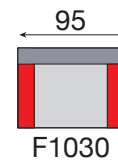
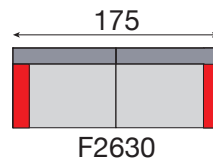
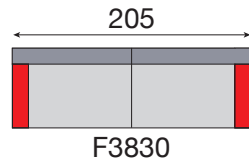

Relaxstelsysteem  
wall-away  
Système relax  
dos-mur



# MORALES



MODERN

EK3833+F2630 • Santa Mineral  
1 x Fan 31 Bador Niagara

MALINAS = toon op toon  
= fil ton sur ton

MORALES = contrasterend garen  
= fil contrasté

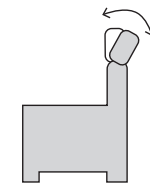
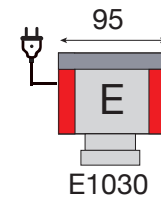
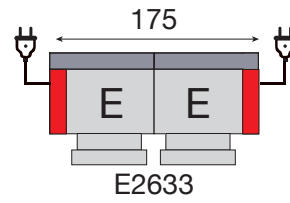
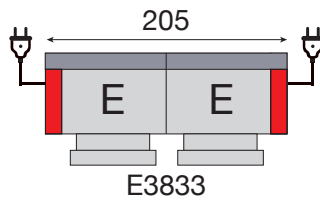
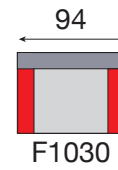
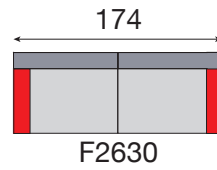
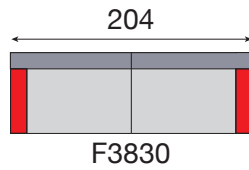

Manuele  
hoofdsteun  
(E codes)

Appui-têtes  
manuelles  
(codes E)

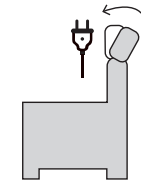
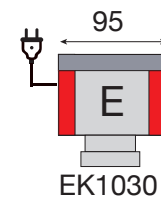
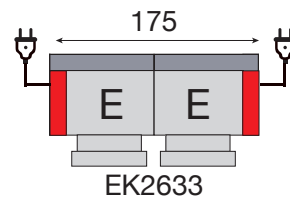
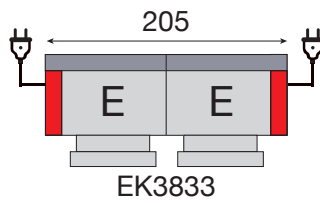

Elektrische  
hoofdsteun  
(EK codes)

Appui-têtes  
électriques  
(codes EK)

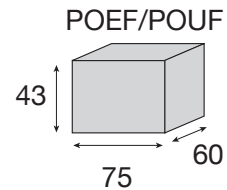
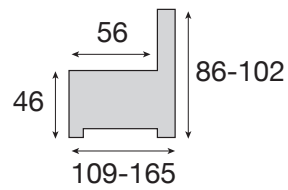

Relaxstelsysteem  
wall-away  
Système relax  
dos-mur

# OVALLE



MODERN

EK3833+F2630 • Beak Natural  
2 x Fan 31 Aris Black

OVALLE = toon op toon  
= fil ton sur ton

## VAST/FIXE

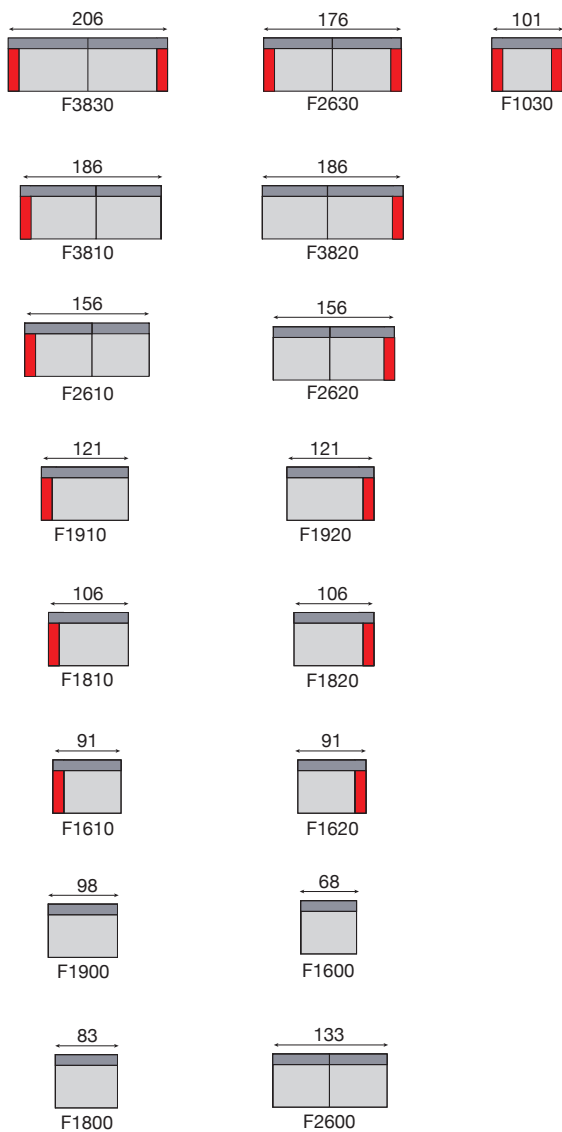

## RELAX ELEKTRISCH/ELECTRIQUE

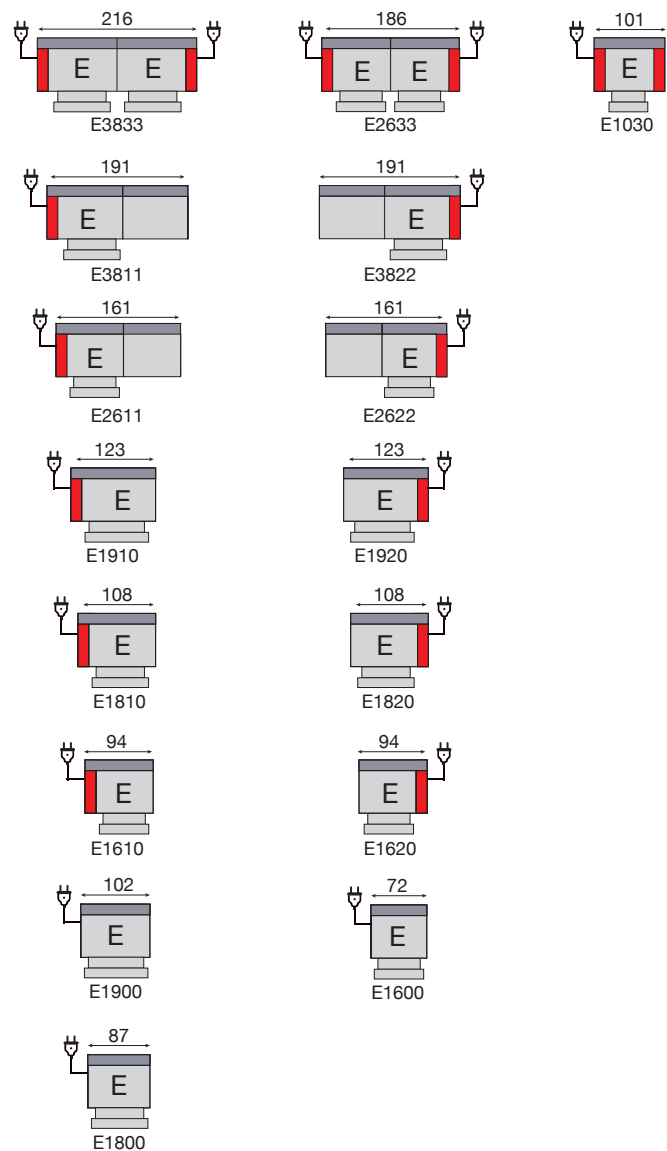

## PAUNO

Relaxsystem  
wall-away  
Système relax  
dos-mur

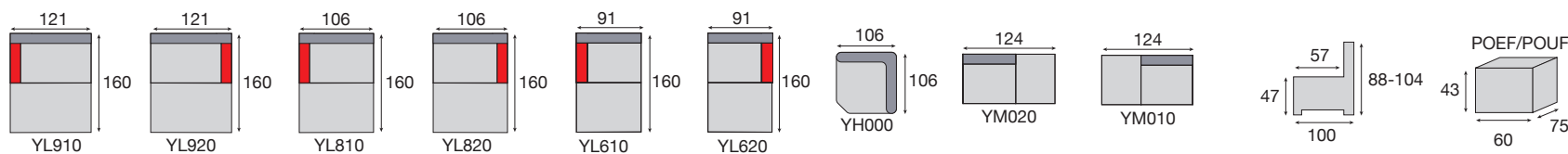

# PAUNO



YL910+E1800+E1800+YH000+F3820 • Bontan Grey  
3 x Fan31 Bitoli Grey

PAUNO = toon op toon  
= fil ton sur ton

PONCHAUT = contrasterend garen  
= fil contrasté

45

## VAST/FIXE

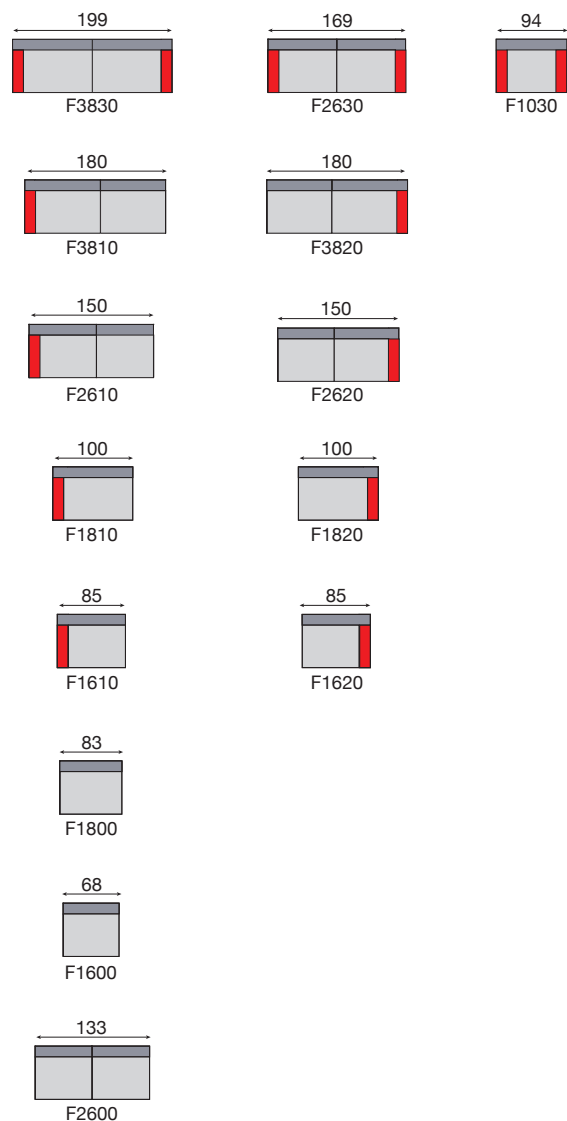

## RELAX ELEKTRISCH/ELECTRIQUE

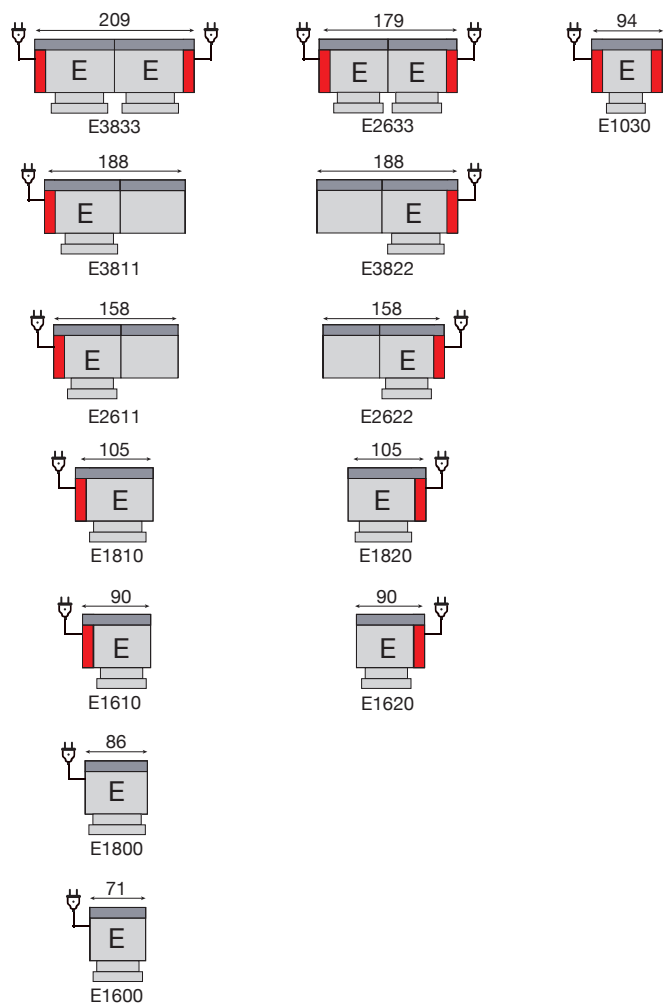

Relaxsystem  
wall-away  
Système relax  
dos-mur

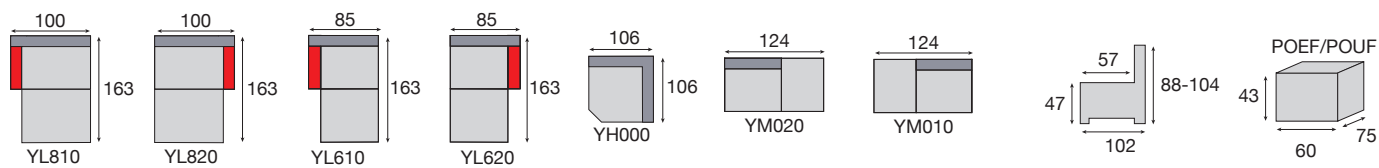

# RIBBA



E3811+YH000+YM020 • Consul Topic Whisky

2 x Fan 31 Bannel Oker  
1 x Fan 31 Bador Hazel

RIBBA = toon op toon  
= fil ton sur ton

RIDLEY = contrasterend garen  
= fil contrasté



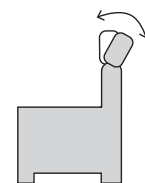
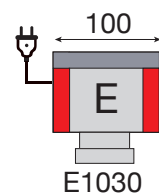
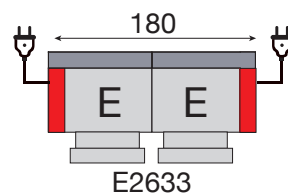
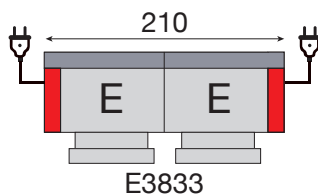
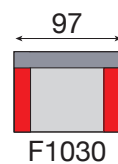
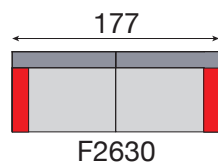
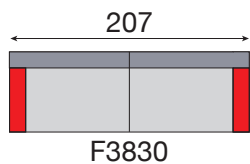

Manuele  
hoofdsteun  
(E-codes)

Apui-têtes  
manuel  
(codes E)

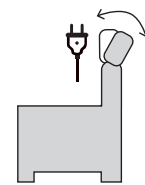
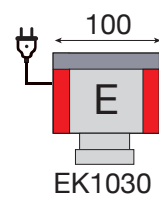
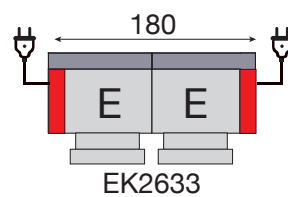
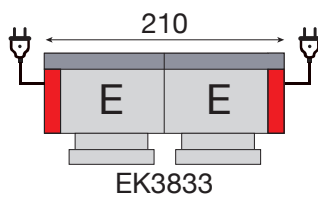

Elektrische  
hoofdsteun  
(EK-codes)

Apui-têtes  
électrique  
(codes EK)

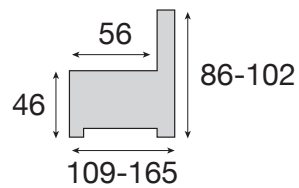



# RUSH



E3833+F2630 • Bost Ocean  
2 x Fan 31 Bador Petrol

ROGAN = toon op toon  
= fil ton sur ton

RUSH = contrasterend garen  
= fil contrasté

## VAST / FIXE

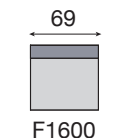
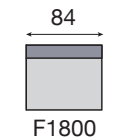
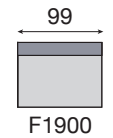
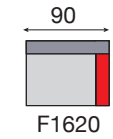
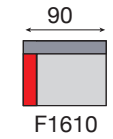
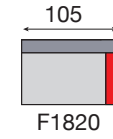
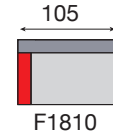
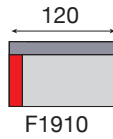

## RELAX ELEKTRISCH / ELECTRIQUE

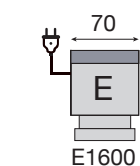
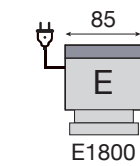
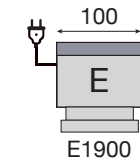
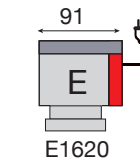
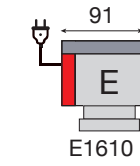
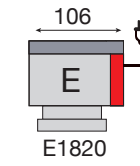
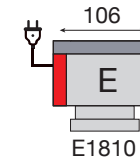
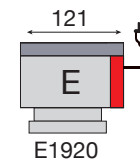
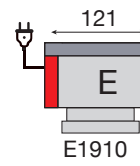

## SELFOSS

Relaxsystem  
wall-away  
Système relax  
dos-mur

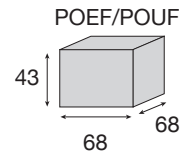
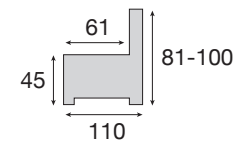
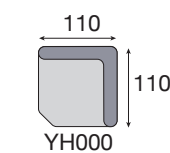
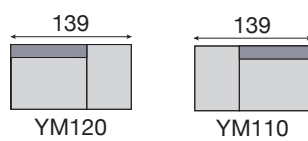
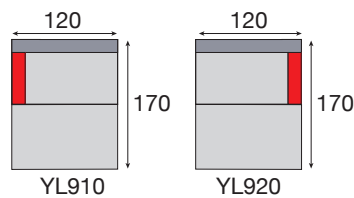

# SELFOSS



MODERN

YL910+F1800+E1820  
Bitoli Grey

SELFOSS = toon op toon  
= fil ton sur ton



## VAST / FIXE

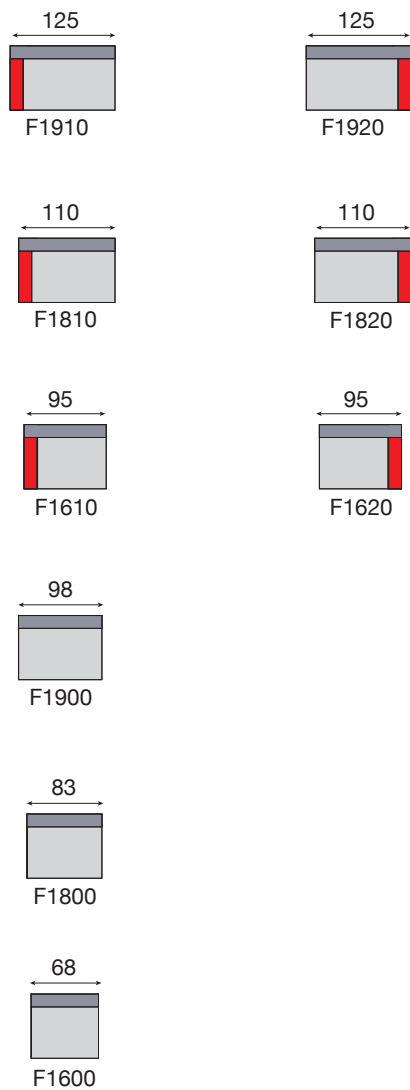

## RELAX ELEKTRISCH / ELECTRIQUE

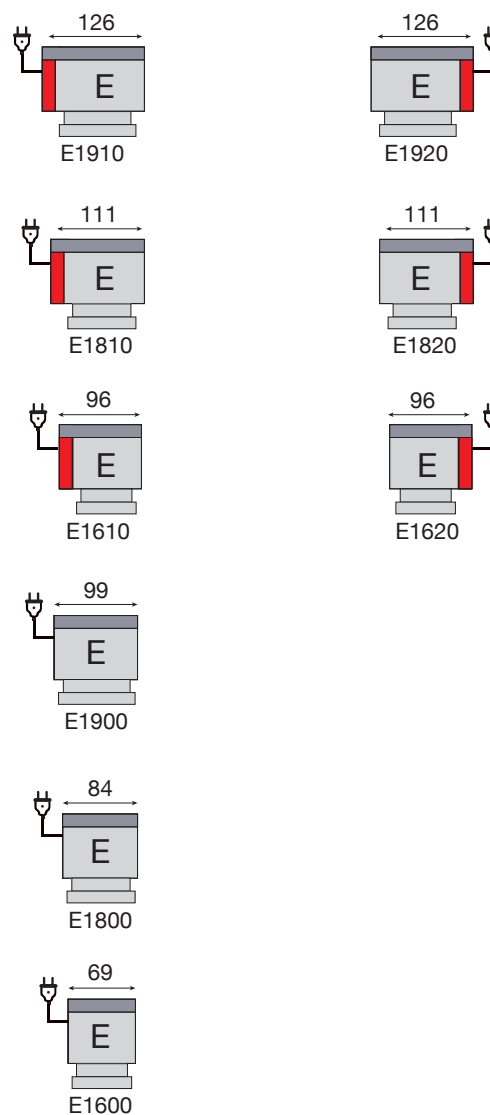

## SEPLAN

Relaxsystem  
wall-away  
Système relax  
dos-mur

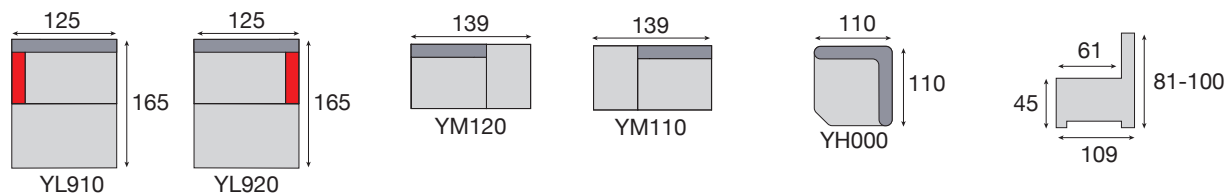

# SEPLAN



MODERN

E1810+E1800+YL920 • Saven Lightgrey  
2 x Fan 31 Setro Darkgrey

SEPLAN = toon op toon  
= fil ton sur ton



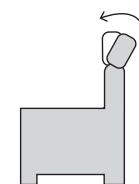
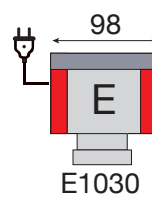
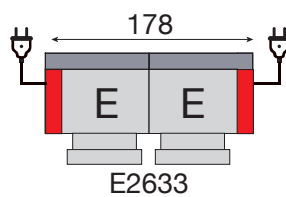
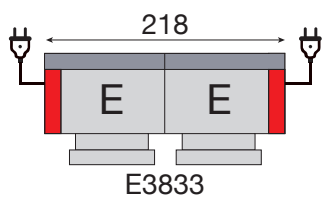
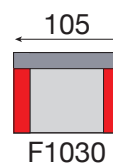
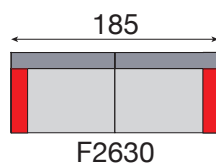
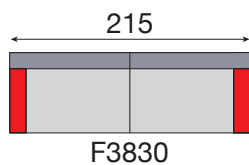

Manuele  
hoofdsteun  
(E-codes)

Apui-têtes  
manuel  
(codes E)

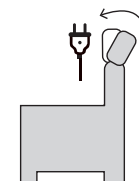
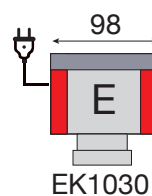
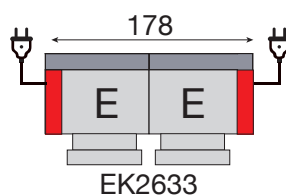
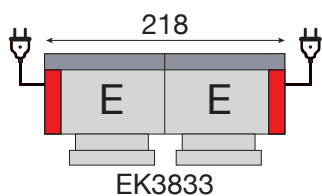

Elektrische  
hoofdsteun  
(EK-codes)

Apui-têtes  
électrique  
(codes EK)

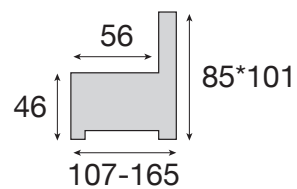

Relaxstysteem  
wall-away  
Système relax  
dos-mur

# UXMAL



MODERN

EK3833+F2630 • Barmon Petrol

UXMAL = toon op toon  
= fil ton sur ton

## VAST/FIXE

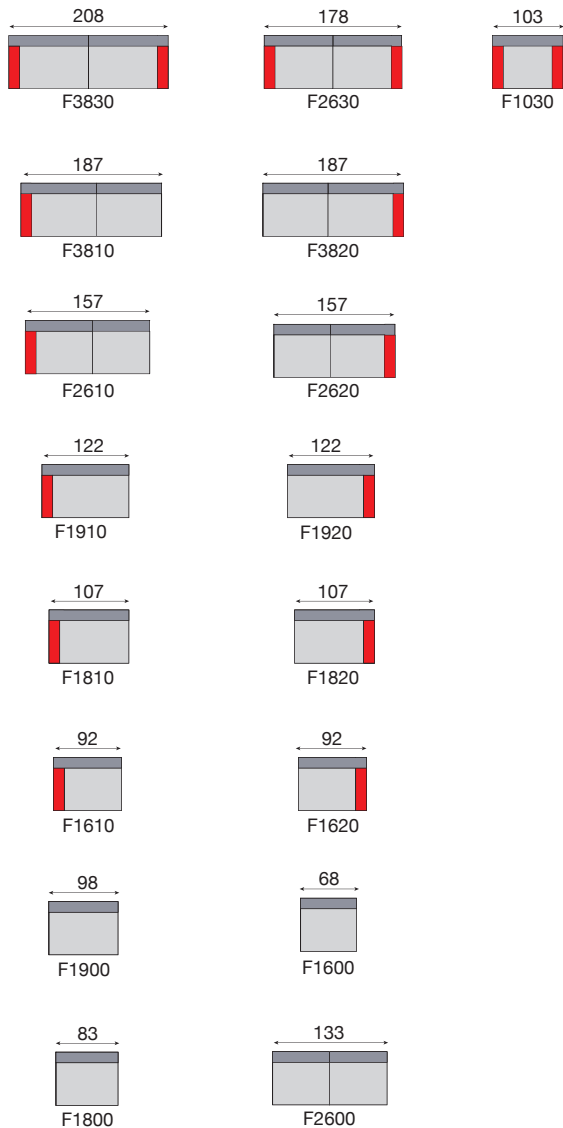

## RELAX ELEKTRISCH/ELECTRIQUE

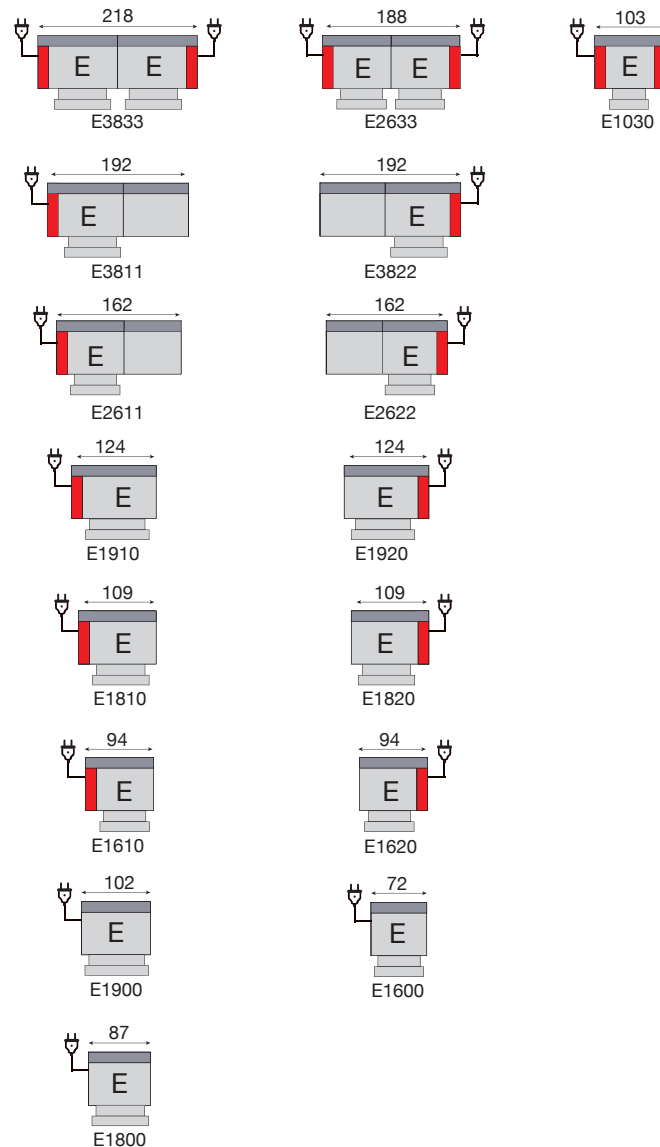

Relaxsystem  
wall-away  
Système relax  
dos-mur

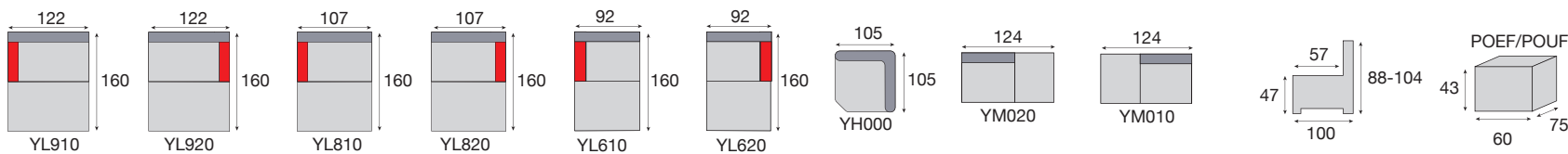



# VALDIVA



YL910+E1920+F2630 • Beak Wood  
2 x Fan31 Bador Darkgrey

VALDIVA = toon op toon  
= fil ton sur ton

MODERN

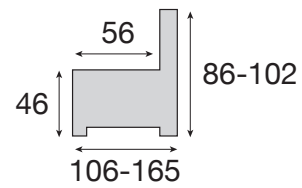
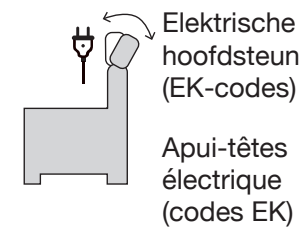
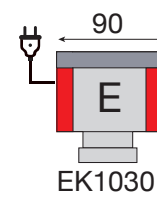
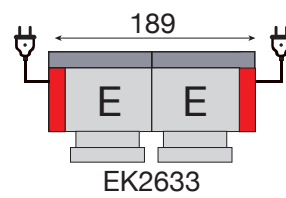
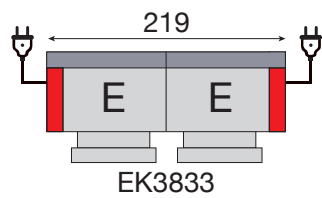
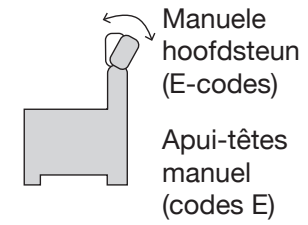
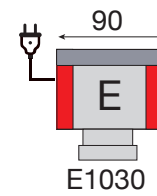
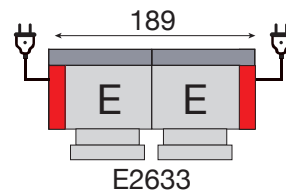
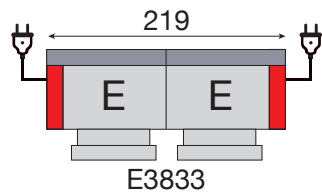
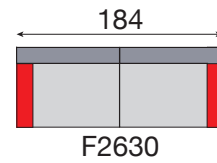
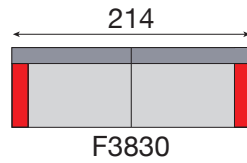

# YONDO



EK3833+F2630 • Beak Steel  
2 x Fan31 Bador Patrol

YOUKO = toon op toon  
= fil ton sur ton

YONDO = contrasterend garen  
= fil contrasté

## VAST / FIXE

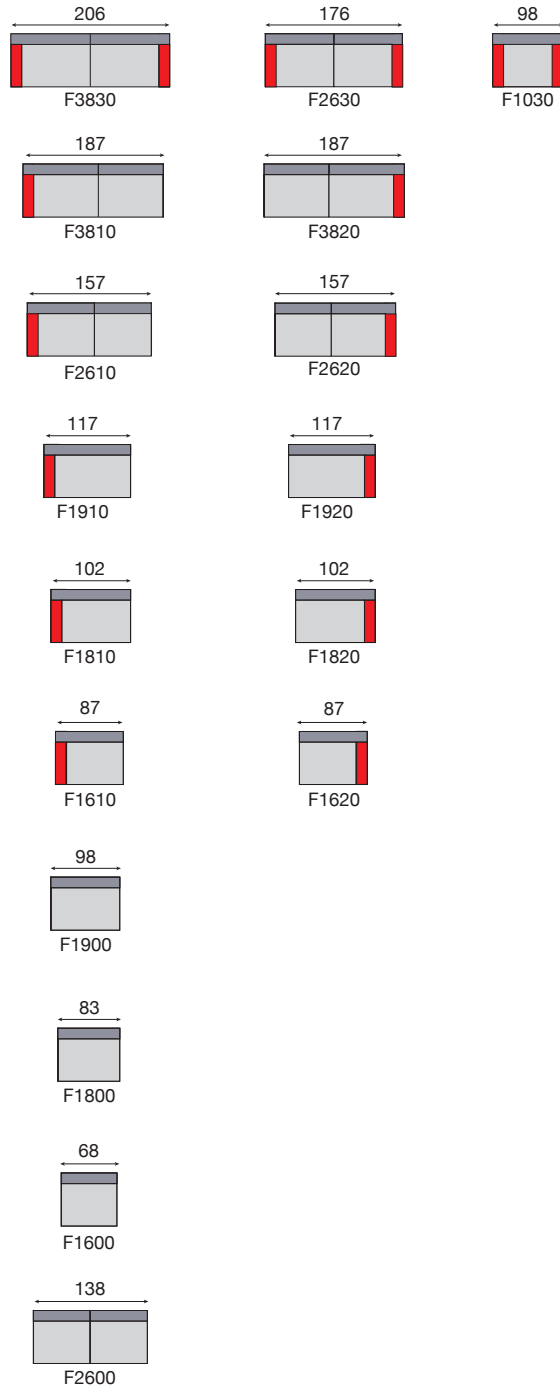

## RELAX ELEKTRISCH / ELECTRIQUE

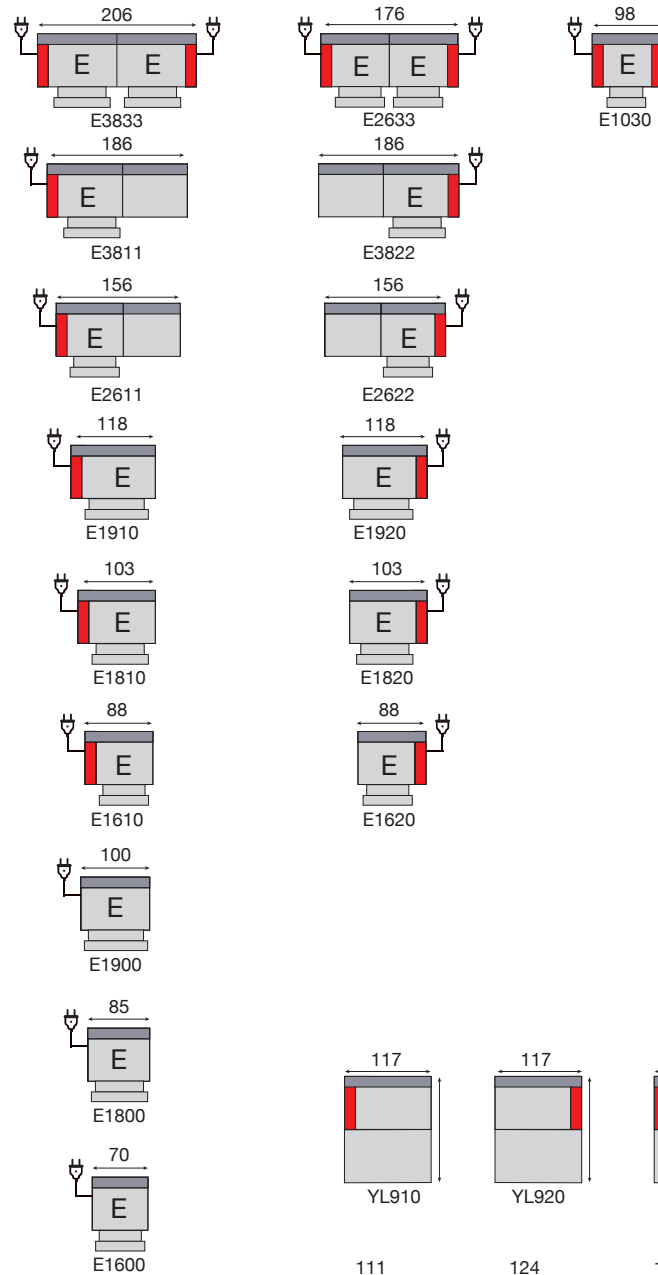

## ZENIKA

Relaxsystem  
wall-away  
Système relax  
dos-mur

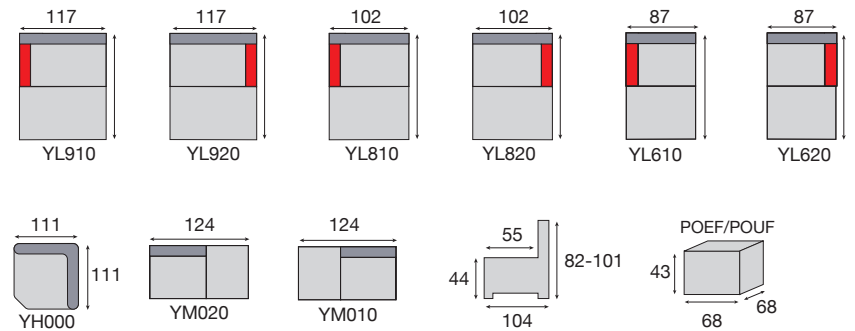

# ZENIKA



MODERN

EK3811+YH000+YM020  
Beak Shitake

ZENIKA = toon op toon  
= fil ton sur ton





DECO

DECO

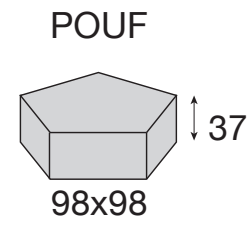
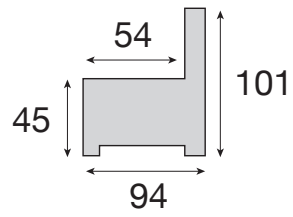
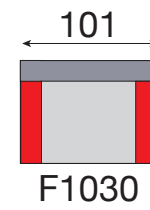
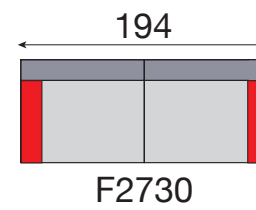
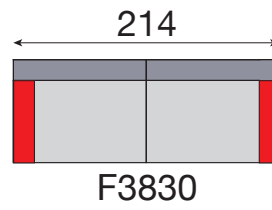
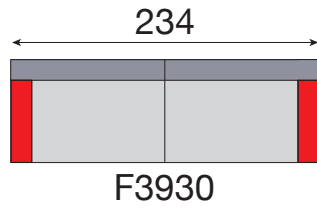



# ANDES



F3830+F2730+F1030  
Dasco Pearl

ANDES = toon op toon  
= fil ton sur ton

# ANGOLA

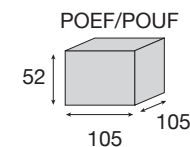
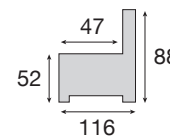
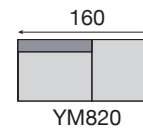
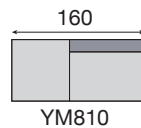
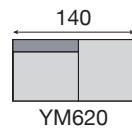
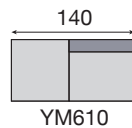
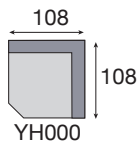
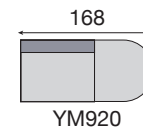
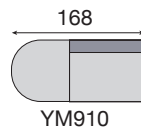
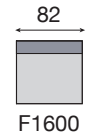
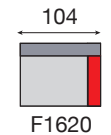
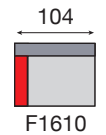
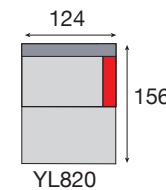
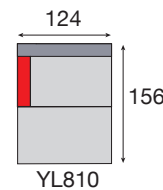
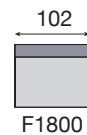
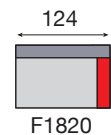
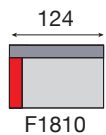
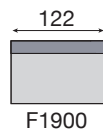
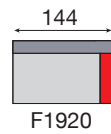
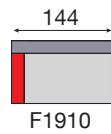
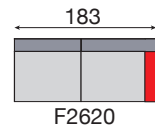
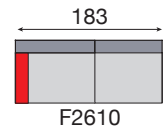
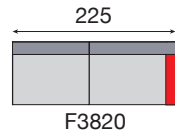
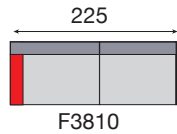
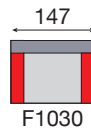
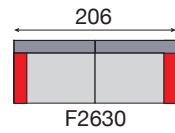
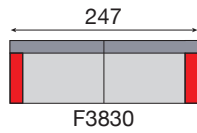

Kleur 1 = romp + zit + grote rugkussens  
 Kleur 2 = middengrote rugkussens  
 Kleur 3 = kleine rugkussens + bies

Couleur 1 = caisse + coussins assise + grands coussins dossiers  
 Couleur 2 = coussins dossier moyenne taille  
 Couleur 3 = petits coussins + passepoile

# ANGOLA



DECO

F3810+YH000+YM920  
Setro Darkgrey+ Setro Darkgrey+Aris Antraciet

ANGOLA = toon op toon  
= fil ton sur ton

# BELIN

Kleur 1 = romp + zit + grote rugkussens  
 Kleur 2 = middengrote rugkussens  
 Kleur 3 = kleine rugkussens + alle knopen

Couleur 1 = caisse + coussins assise +  
 grands coussins dossier

Couleur 2 = coussins dossier medium taille

Couleur 3 = petits coussins + tous les boutons

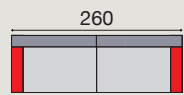

F3030

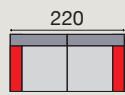

F2030



F1030

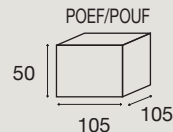
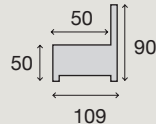

F3030+F1030 • Alod Lightgrey + Alod Darkgrey + Adonis Grey  
 Poef • Adonis Grey

BELIN = toon op toon  
 = fil ton sur ton

BELIZE = contrasterend garen  
 = fil contrasté

# COCOON

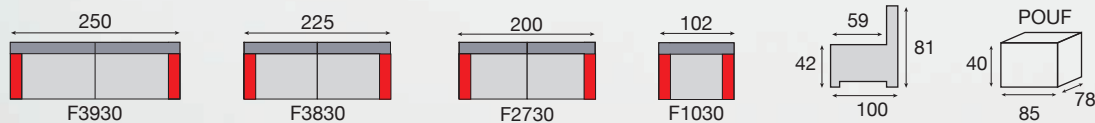

F3930 • Aris Forest / F2730 • Aris Mud  
 F1030 • Belux Biscuit / POEF • Catri Sun  
 3 x Fan31 Catri Sun / 2 x Fan35 Aris Mud

COCOON = toon op toon  
 = fil ton sur ton

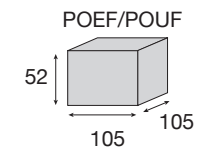
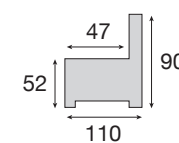
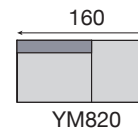
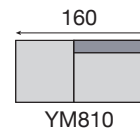
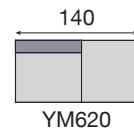
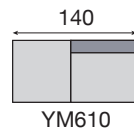
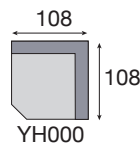
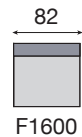
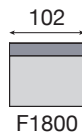
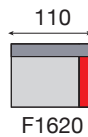
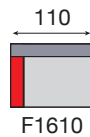
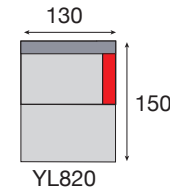
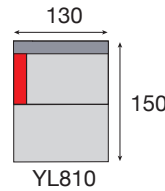
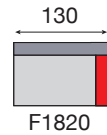
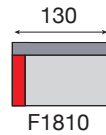
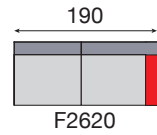
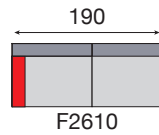
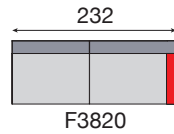
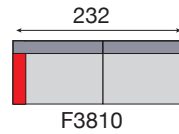
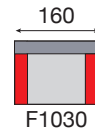
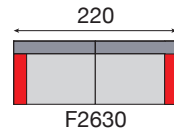
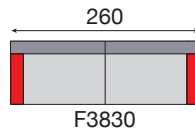

Kleur 1 = romp + zit + grote rugkussens  
 Kleur 2 = middengrote rugkussens  
 Kleur 3 = kleine rugkussens

Couleur 1 = caisse + coussins assise + grands coussins dossier  
 Couleur 2 = coussins dossier medium taille  
 Couleur 3 = petits coussins

# BRETON



YL810+F3820  
Bicti Beluga + Bicti Beluga + Storza Antraciet

BRETON = toon op toon  
= fil ton sur ton

# BRETON



Afmetingen zie p. 70  
Dimensions p. 70

F3830+F1030 • Barmon Mustard + Mustard + Terra

BRETON = toon op toon  
= fil ton sur ton



# BRETON

DECO



Afmetingen zie p. 70  
Dimensions p. 70

F3810+YH000+YM620 • Benjo Almond

BRETON = toon op toon  
= fil ton sur ton

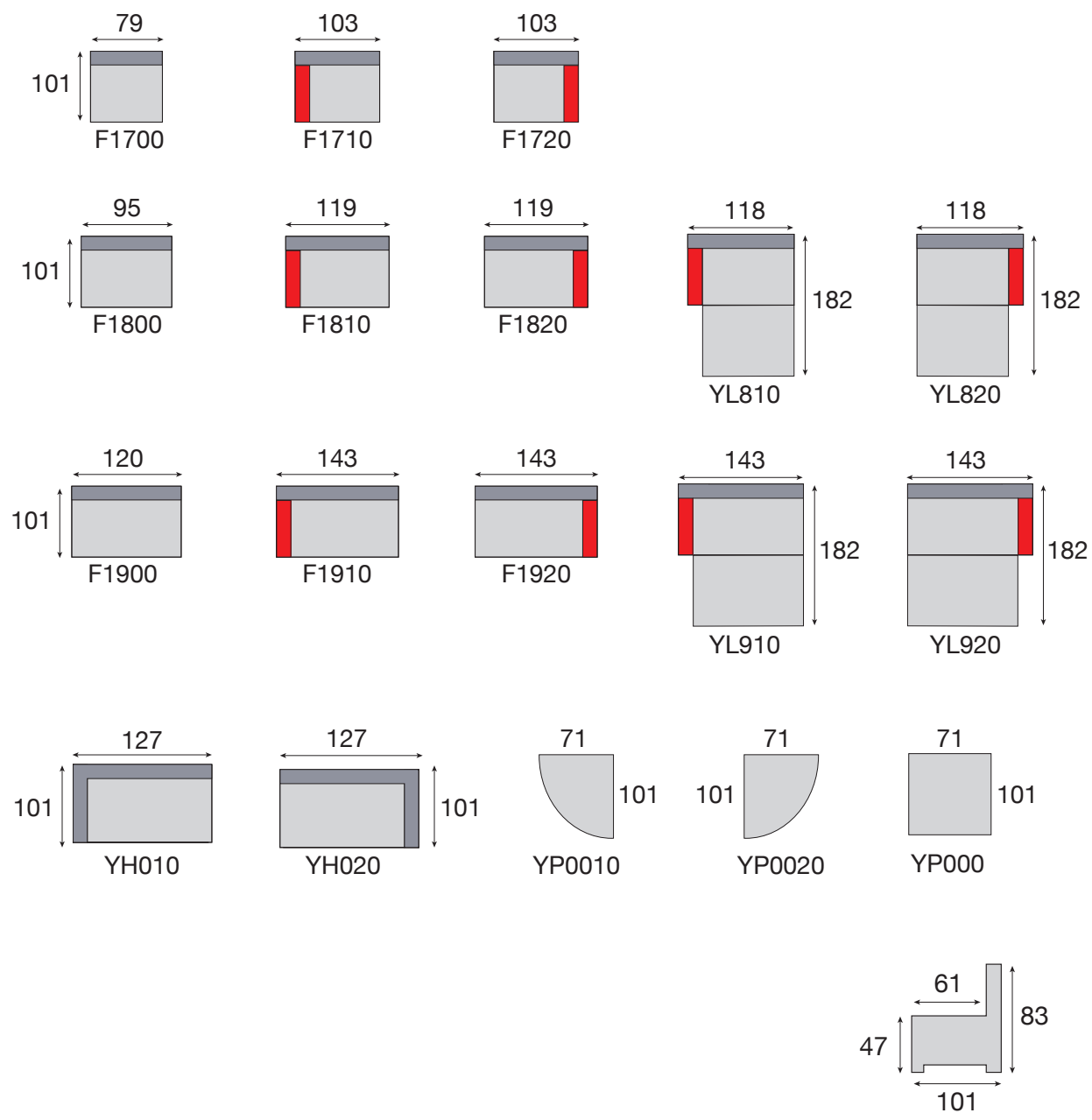

# CARLA



DECO

F1810+F1800+YH020+F1800+YP0020 • Sastel Moonbean  
2 x Fan 31 Bador Darkgrey

CARLA = toon op toon  
= fil ton sur ton

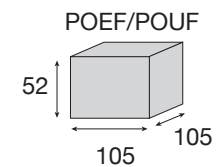
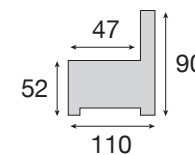
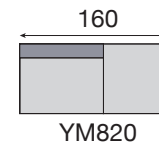
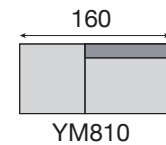
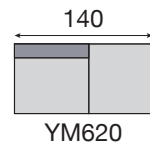
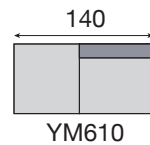
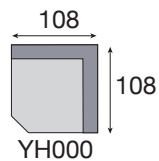
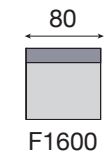
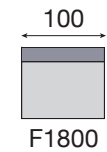
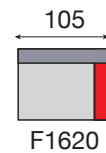
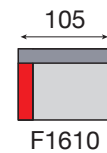
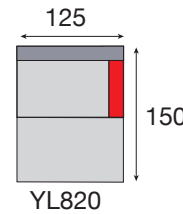
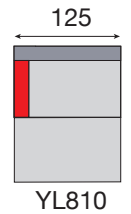
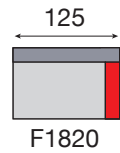
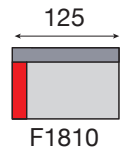
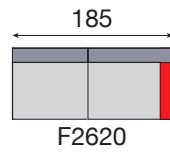
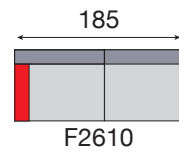
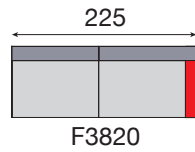
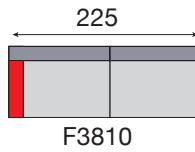
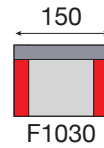
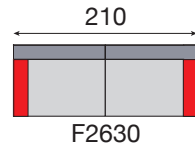
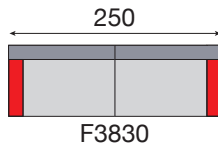

Kleur 1 = romp + zit + grote rugkussens  
 Kleur 2 = middengrote rugkussens  
 Kleur 3 = kleine rugkussens

Couleur 1 = caisse + coussins assise + grands coussins dossier  
 Couleur 2 = coussins dossier medium taille  
 Couleur 3 = petits coussins

# CASALE



F3810+YH000+YM820  
Colo Argent



CASALE = toon op toon  
= fil ton sur ton

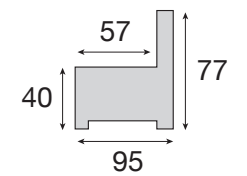
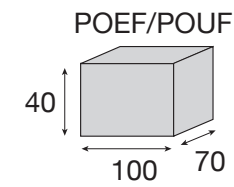
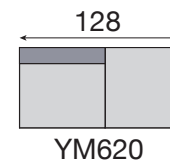
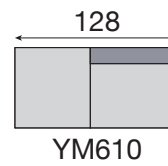
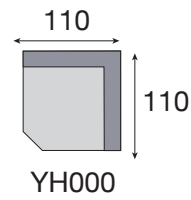
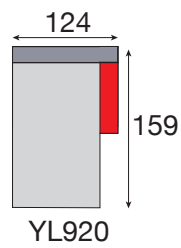
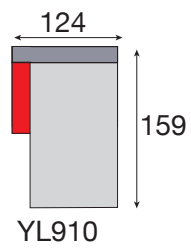
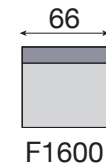
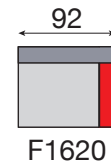
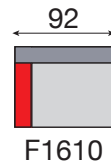
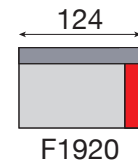
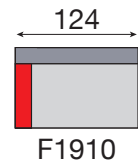
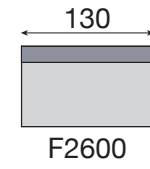
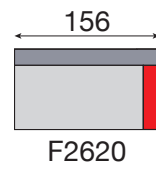
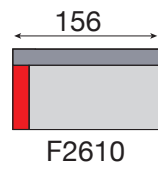

# DIMBARA



F1910+F1900+YH000+YM620 • Saven Ecrú  
3 x Fan 31 Bador Ecrú

DIMBARA = toon op toon  
= fil ton sur ton

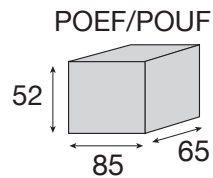
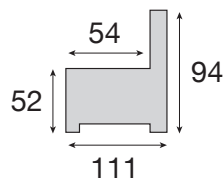
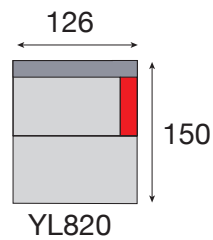
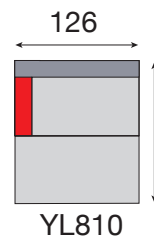
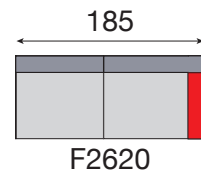
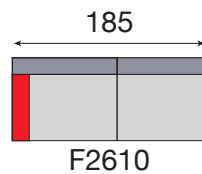
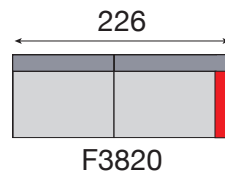
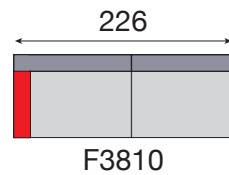
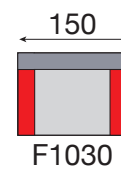
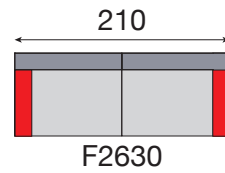
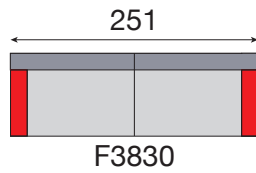

Kleur 1 = romp + zit + grote rugkussens  
 Kleur 2 = middengrote rugkussens  
 Kleur 3 = kleine rugkussens

Couleur 1 = caisse + coussins assise + grands coussins dossier  
 Couleur 2 = coussins dossier medium taille  
 Couleur 3 = petits coussins



# DONITA



F3810+YL820 • Sastel Moonbean

DONITA = toon op toon  
= fil ton sur ton

66



F1600

95

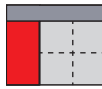

F1610

95

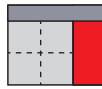

F1620

66



YS600

95

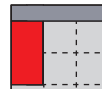

YS610

95

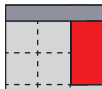

YS620

95



YL610

95

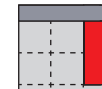

YL620

98



F1900

127

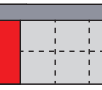

F1910

127

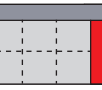

F1920

98



YS900

127

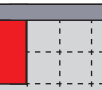

YS910

127

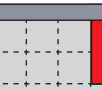

YS920

127

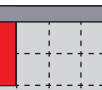

YL910

127

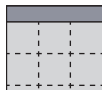

YL920

130



F2600

159

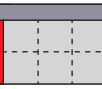

F2610

159

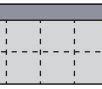

F2620

134

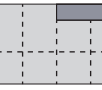

YM610

134

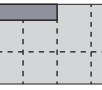

YM620

109



YH000

100



YP000

57



99

# FORSA

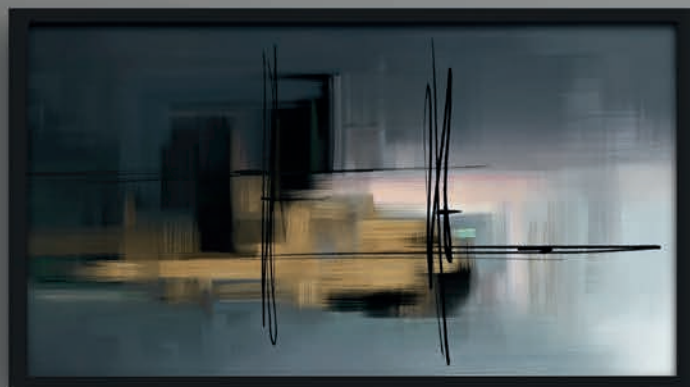

Bob poef  
Berib Grey

Bobette poef  
Aris Steel

YL910+F2600+YH000+YM620 • Bost Ash

2 x Fan31 Aris Steel  
2 x Fan31 Berib Grey

FORSA = toon op toon  
= fil ton sur ton

## FRONTINO

Kleur 1 = massa  
 Kleur 2 = bies

Couleur 1 = masse  
 Couleur 2 = passepoile

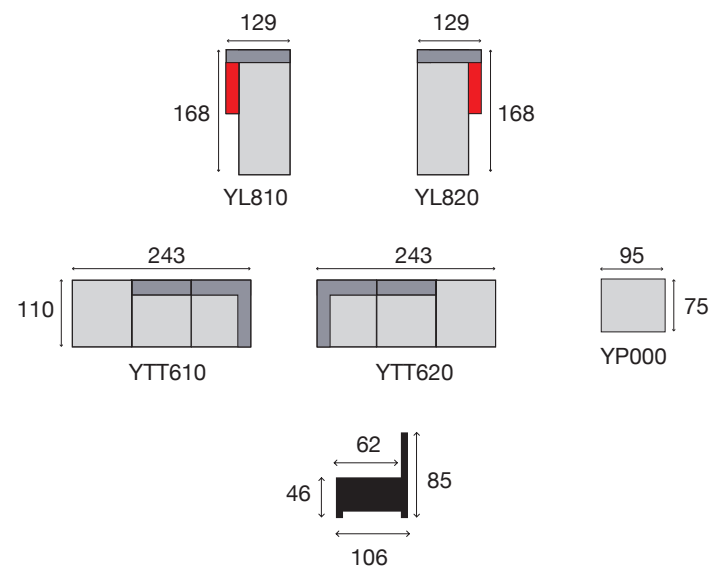
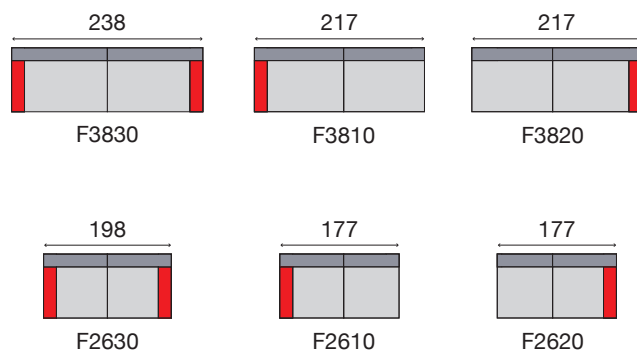

# FRONTINO



DECO

YTT610+F3820 • Santa Antartica + Bador Antraciet  
2 x Fan31 Bador Antraciet

FRONTINO = toon op toon  
= fil ton sur ton

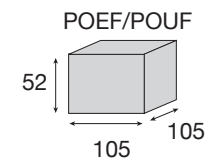
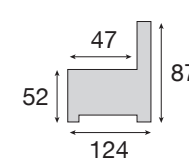
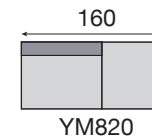
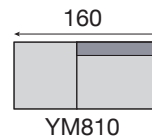
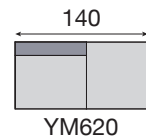
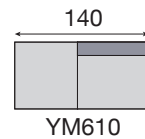
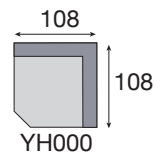
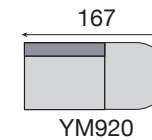
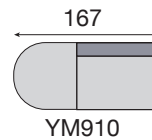
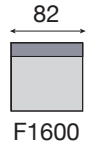
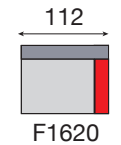
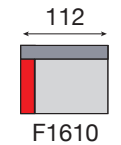
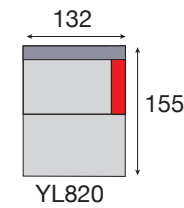
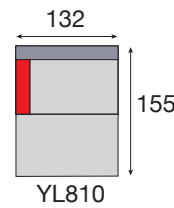
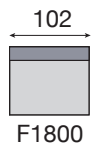
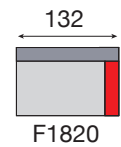
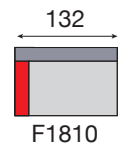
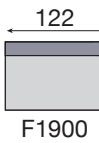
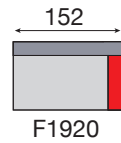
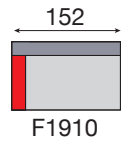
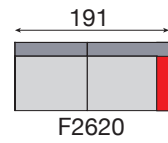
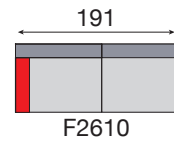
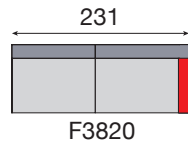
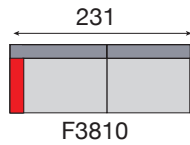
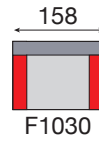
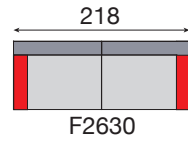
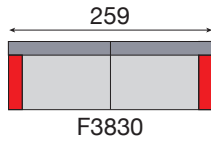

Kleur 1 = romp + zit + grote rugkussens  
 Kleur 2 = middengrote rugkussens  
 Kleur 3 = kleine rugkussens

Couleur 1 = caisse + coussins assise + grands coussins dossier  
 Couleur 2 = coussins dossier medium taille  
 Couleur 3 = petits coussins

# GLENN



F1910+F1920+F1030  
Setro Blue + Setro Blue + Aris Deepblue

GLENN = toon op toon  
= fil ton sur ton

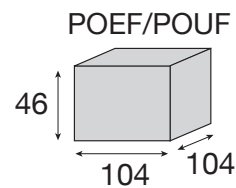
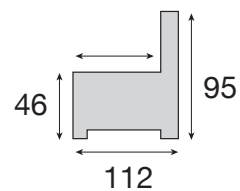
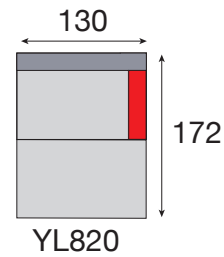
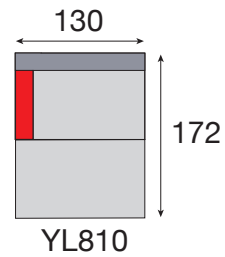
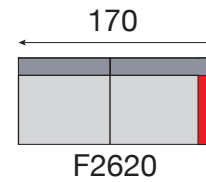
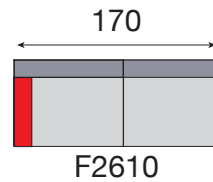
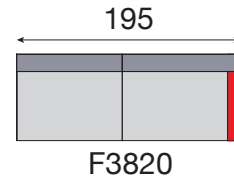
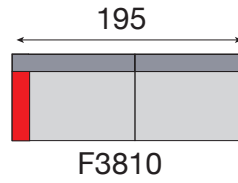
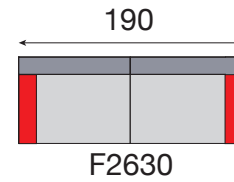
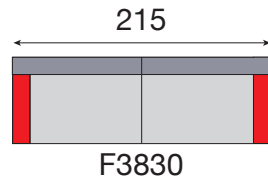

Kleur 1 = romp + zit + grote rugkussens  
Kleur 2 = lendenkussens

Couleur 1 = caisse + coussins assise +  
grands coussins dossiers  
Couleur 2 = coussins lombaires



# GRANO



DECO

F2610+YL820 • Dasco Pearl

GRANO = toon op toon  
= fil ton sur ton

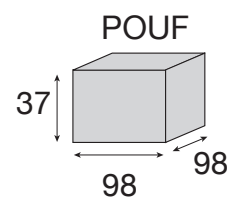
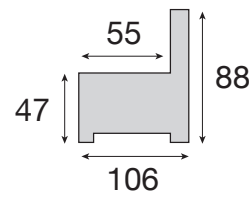
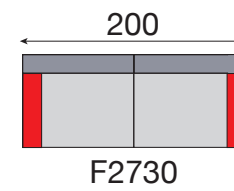
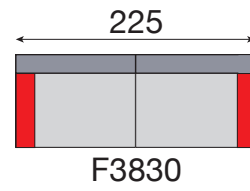
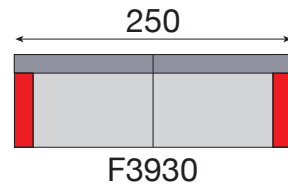

# GREYTON

DECO



F3830 • Bress Ivoor  
Poef • Setro Forest  
1 x Fan31 Setro Forest

GREYTON = toon op toon  
= fil ton sur ton

# GRANO



Afmetingen zie p. 88  
Dimensions p. 88

F3830+POEF • Bandy White

92

  
H<sup>2</sup>O<sup>h</sup>  
just with water

GRANO = toon op toon  
= fil ton sur ton

# KOTOR



DECO

Afmetingen zie p. 94  
Dimensions p. 94

F1910+F1920+F1030  
Bandy Khaki + Bandy Khaki + Aris Mud



KOTOR = toon op toon  
= fil ton sur ton

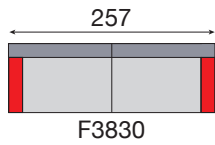

F3830

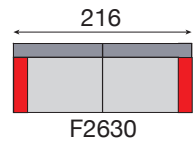

F2630

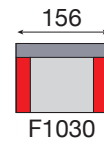

F1030

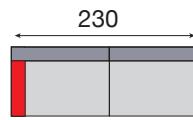

F3810

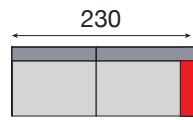

F3820

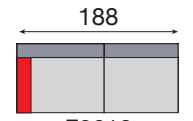

F2610

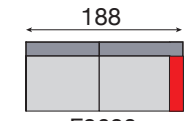

F2620

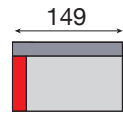

F1910

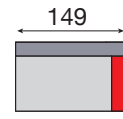

F1920

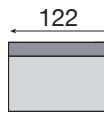

F1900

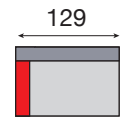

F1810

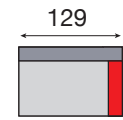

F1820

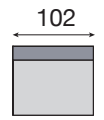

F1800

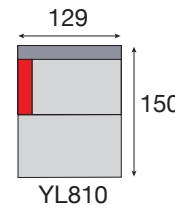

YL810

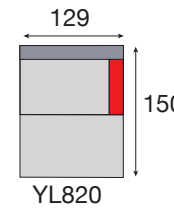

YL820

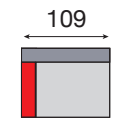

F1610

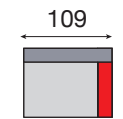

F1620

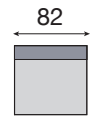

F1600

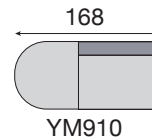

YM910

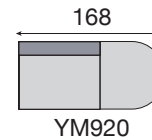

YM920

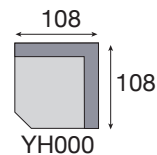

YH000

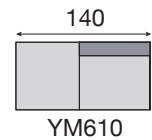

YM610

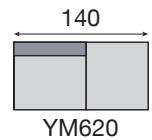

YM620

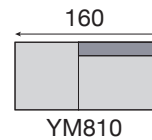

YM810

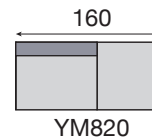

YM820

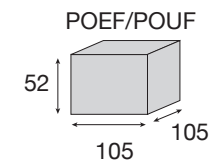
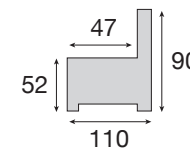

POEF/POUF

Kleur 1 = romp + zit + grote rugkussens  
 Kleur 2 = middengrote rugkussens  
 Kleur 3 = kleine rugkussens

Couleur 1 = caisse + coussins assise + grands coussins dossier  
 Couleur 2 = coussins dossier medium taille  
 Couleur 3 = petits coussins

# KOTOR



DECO

F1910+F1900+YH000+YM920  
Barmon Coconut + Barmon Coconut + Bitoli Mouse

KOTOR = toon op toon  
= fil ton sur ton



F1910+F1920+POEF

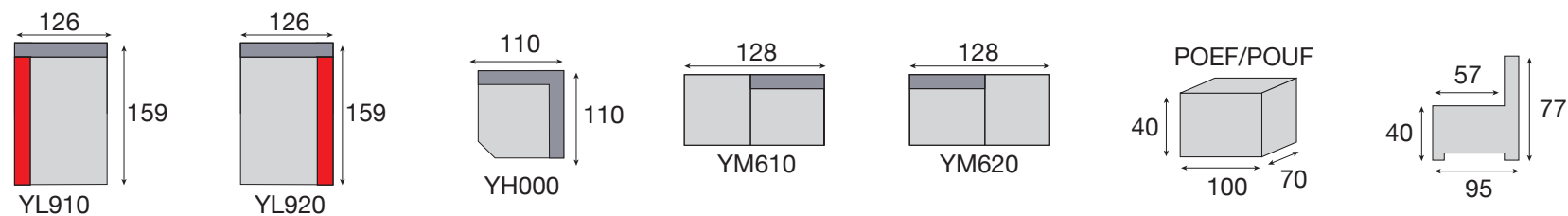
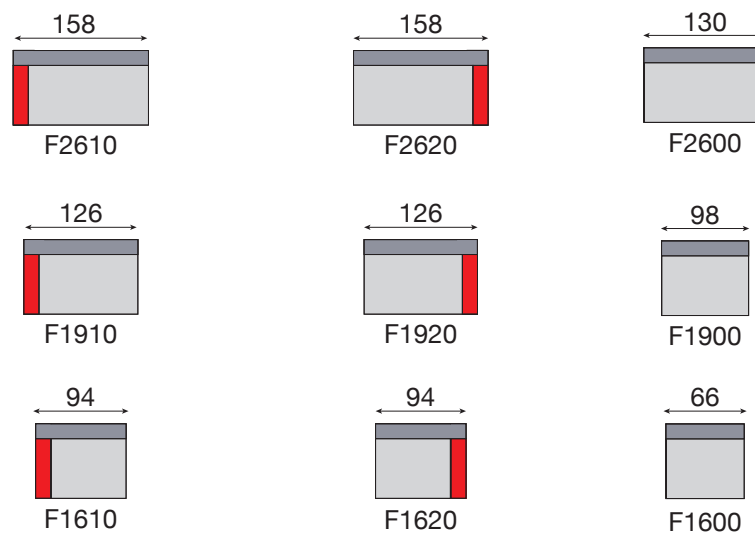



# LIAM



F2610+YL920 • Barmon Azur  
2 x Fan31 Aris Deepblue

LIAM = toon op toon  
= fil ton sur ton

LOLAY = contrasterend garen  
= fil contrasté

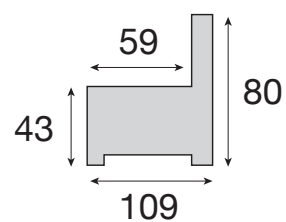
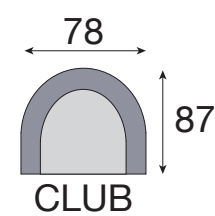
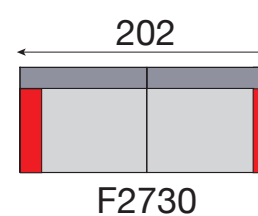
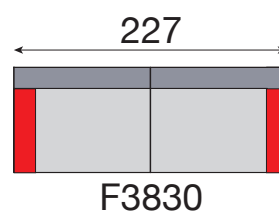
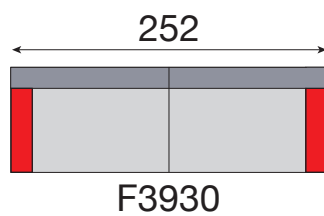

# MAEVE



DECO

F3930 Bitoli Green + Club Storza Forest + YP000 Storza Forest

1 x Fan31 Storza Forest

1 x Fan31 Bador Petrol

MAEVE = toon op toon  
= fil ton sur ton

# MAGNOLA

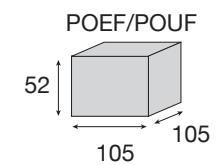
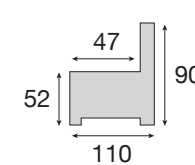
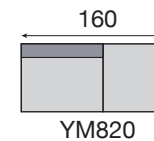
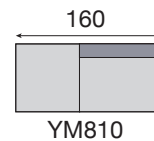
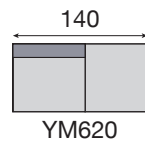
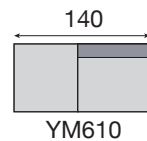
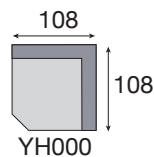
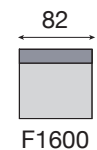
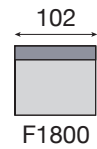
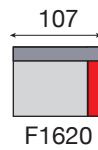
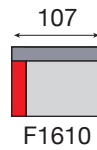
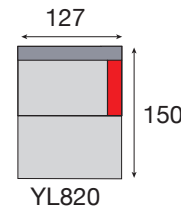
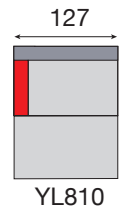
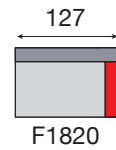
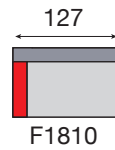
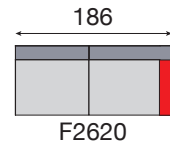
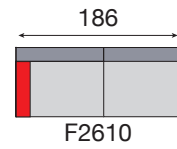
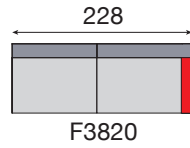
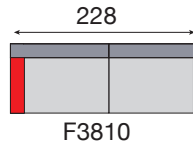
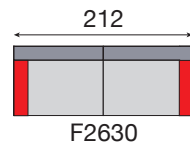
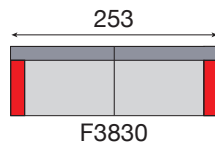

Kleur 1 = romp + zit + grote rugkussens  
 Kleur 2 = middengrote rugkussens  
 Kleur 3 = kleine rugkussens

Couleur 1 = caisse + coussins assise + grands coussins dossier  
 Couleur 2 = coussins dossier medium taille  
 Couleur 3 = petits coussins

# MAGNOLA



F3830+F1030  
Dasco Brique + Dasco Brique + Dasco Brique

MAGNOLA = toon op toon  
= fil ton sur ton

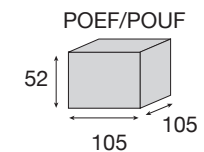
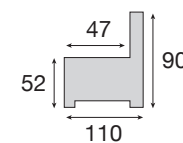
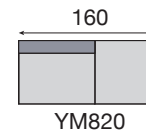
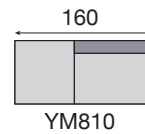
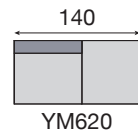
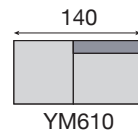
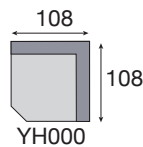
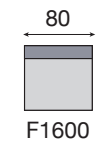
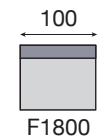
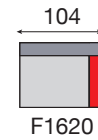
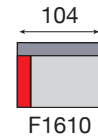
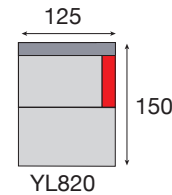
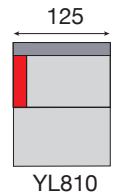
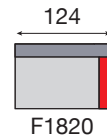
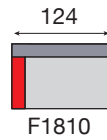
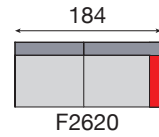
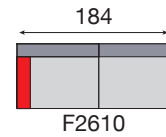
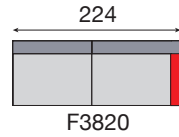
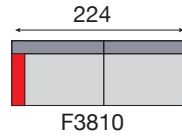
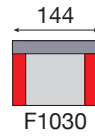
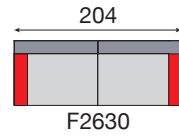
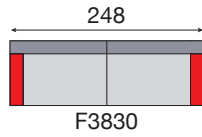

Kleur 1 = romp + zit + grote rugkussens  
 Kleur 2 = middengrote rugkussens  
 Kleur 3 = kleine rugkussens

Couleur 1 = caisse + coussins assise + grands coussins dossier  
 Couleur 2 = coussins dossier medium taille  
 Couleur 3 = petits coussins

# MARLON



F3830+F1030+YP000 • Dasco Pearl

MARLON = toon op toon  
= fil ton sur ton

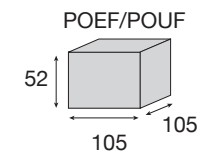
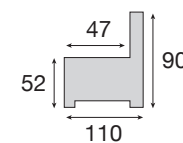
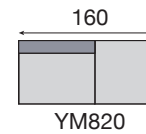
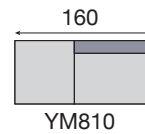
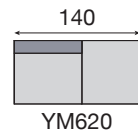
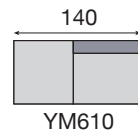
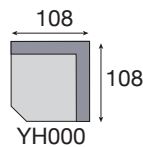
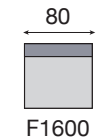
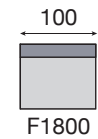
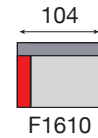
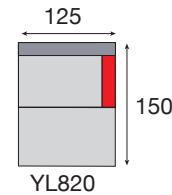
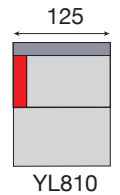
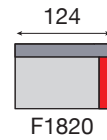
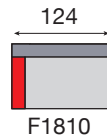
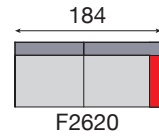
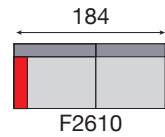
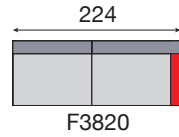
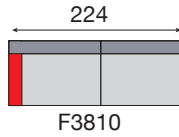
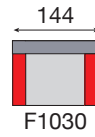
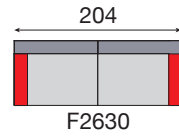
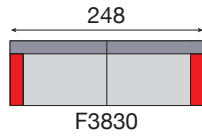

Kleur 1 = romp + zit + grote rugkussens  
 Kleur 2 = middengrote rugkussens  
 Kleur 3 = kleine rugkussens

Couleur 1 = caisse + coussins assise + grands coussins dossier  
 Couleur 2 = coussins dossier medium taille  
 Couleur 3 = petits coussins



# MARLON



F1030 • Storza Antraciet + Storza Antraciet + Ago Antraciet  
F3810+YH000+YM820 •  
Ago Antraciet + Ago Antraciet + Storza Antraciet



MARLON = toon op toon  
= fil ton sur ton

Kleur 1 = romp  
 Kleur 2 = bias + knoppen (detail)

Couleur 1 = caisse  
 Couleur 2 = passepoile + boutons (détail)

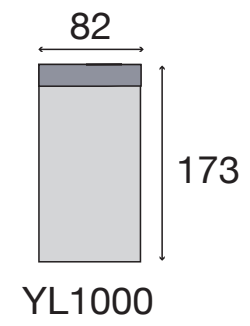
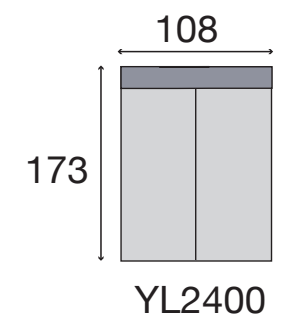
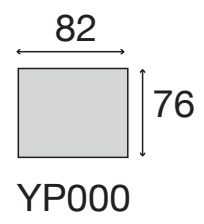
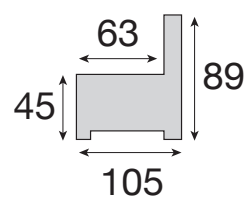
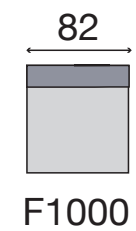
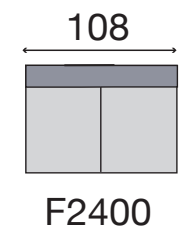
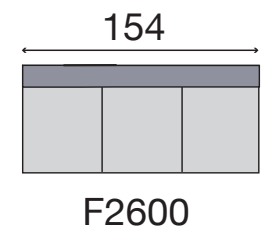
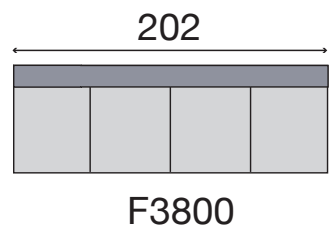

# MELODIE



YL2400+F3800+F1000 • Golf Ciel

MELODIE = toon op toon  
= fil ton sur ton

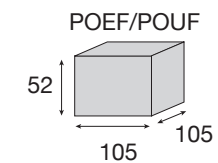
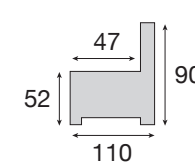
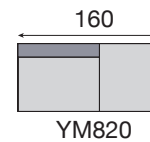
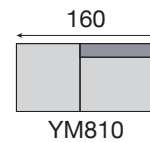
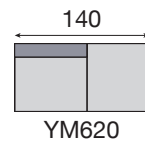
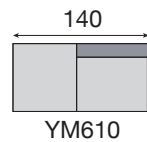
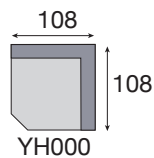
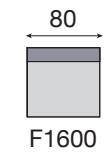
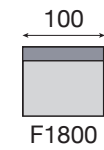
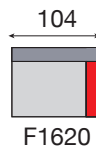
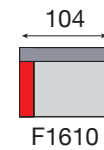
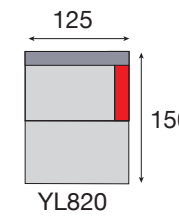
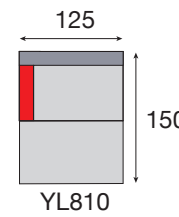
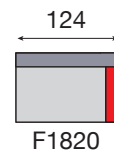
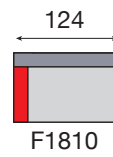
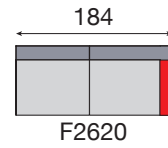
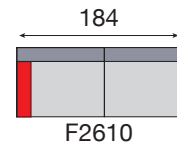
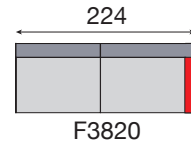
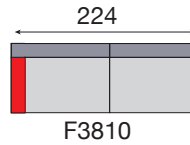
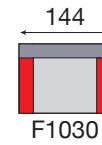
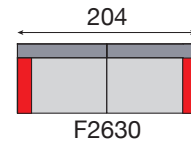
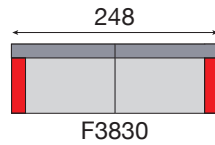

Kleur 1 = romp + zit + grote rugkussens  
 Kleur 2 = middengrote rugkussens  
 Kleur 3 = kleine rugkussens

Couleur 1 = caisse + coussins assise + grands coussins dossier  
 Couleur 2 = coussins dossier medium taille  
 Couleur 3 = petits coussins

# MOIANO



F3830 • Bità Silver

MOIANO = toon op toon  
= fil ton sur ton

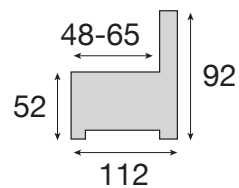
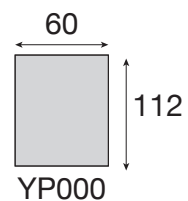
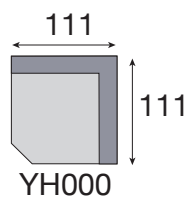
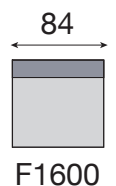
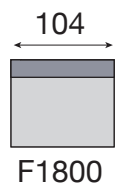
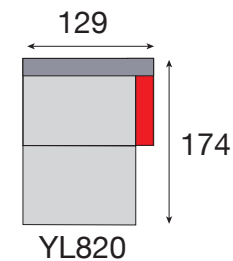
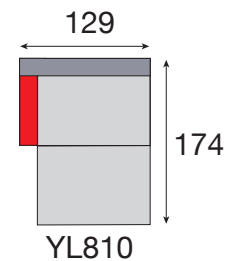
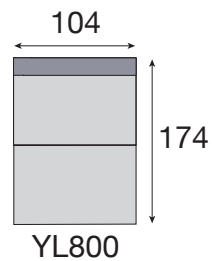
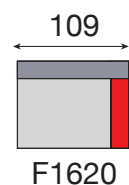
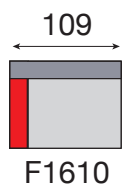
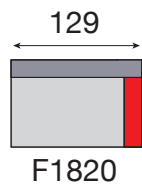
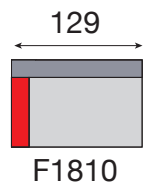
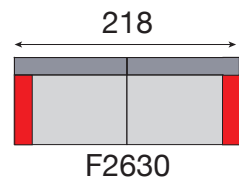
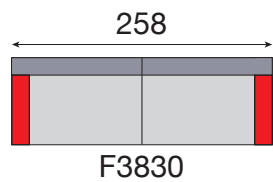

# MONO



F1800+F1800+YL800 • Dali Silver

MONO = toon op toon  
= fil ton sur ton

DECO

## MONTONE

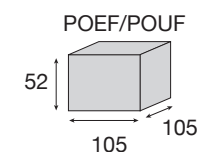
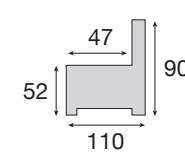
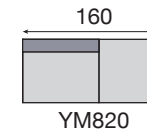
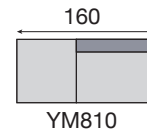
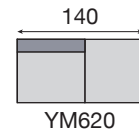
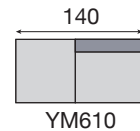
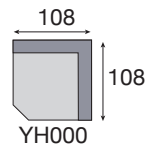
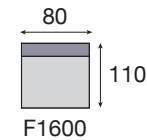
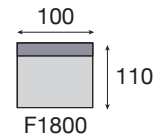
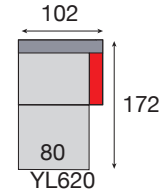
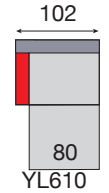
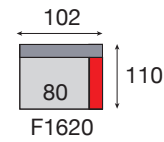
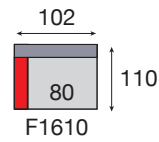
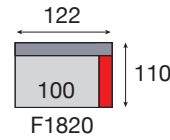
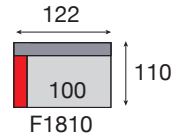
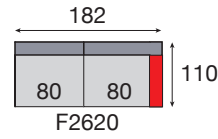
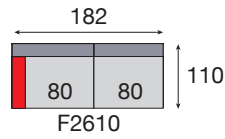
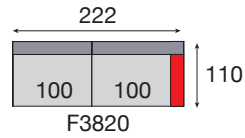
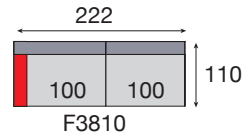
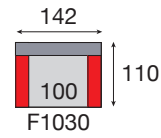
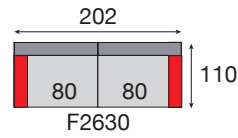
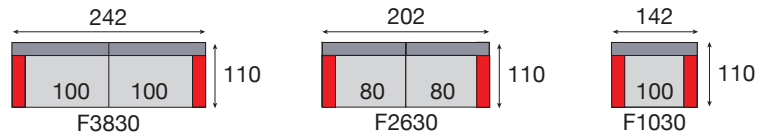

Kleur 1 = romp + zit + grote rugkussens  
 Kleur 2 = middengrote rugkussens  
 Kleur 3 = kleine rugkussens

Couleur 1 = caisse + coussins assise + grands coussins dossier  
 Couleur 2 = coussins dossier medium taille  
 Couleur 3 = petits coussins



# MONTONE



F3830 • Dasco Toffee + Dasco Toffee + Bador Darkgrey  
F1030 • Bador Darkgrey + Bador Darkgrey + Dasco Toffee  
YP000 • Dasco Toffee

MONTONE = toon op toon  
= fil ton sur ton

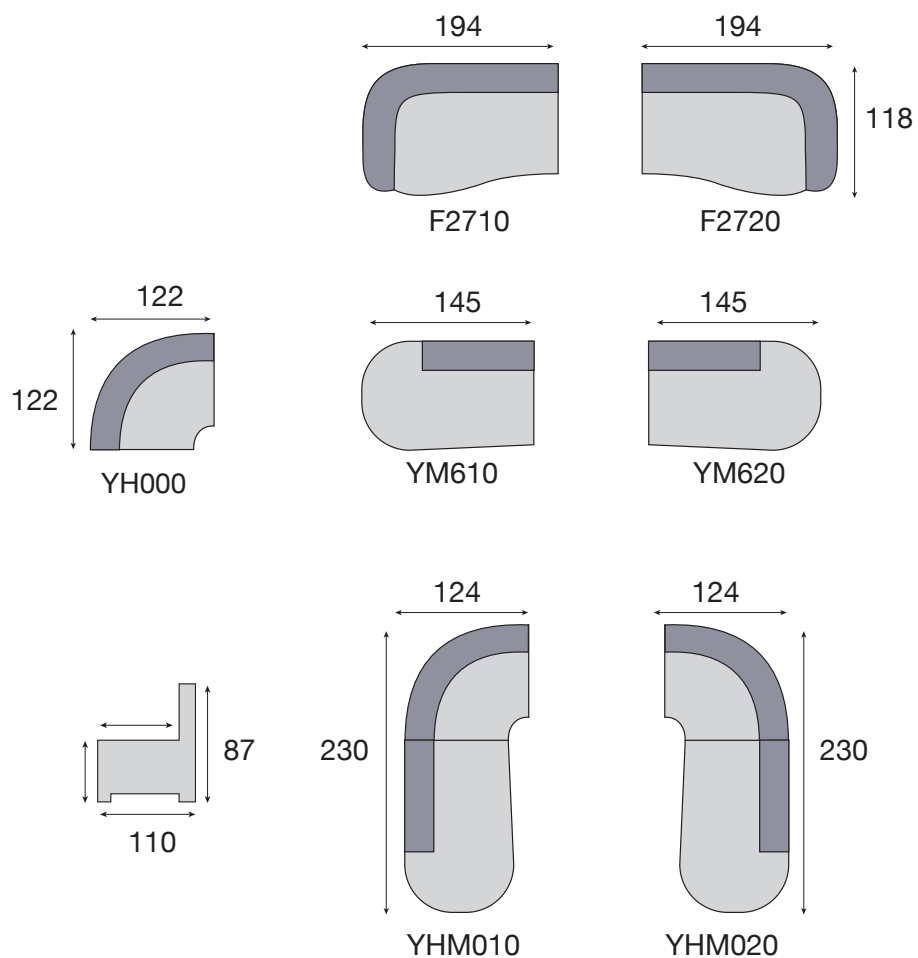

Kleur 1 = romp + zitkussens  
 Kleur 2 = grote rugkussens  
 Kleur 3 = kleine rugkussens

Couleur 1 = caisse + coussins d'assise +  
 Couleur 2 = grands coussins dossier  
 Couleur 3 = petits coussins

# MUMBAI



F2710+YH000+YM620  
Santa Mineral + Santa Mineral + Bador Niagara

MUMBAI = toon op toon  
= fil ton sur ton

MUMFORD = contrasterend garen  
= fil contrasté

YP1000



120 x 108 x 41

YR000

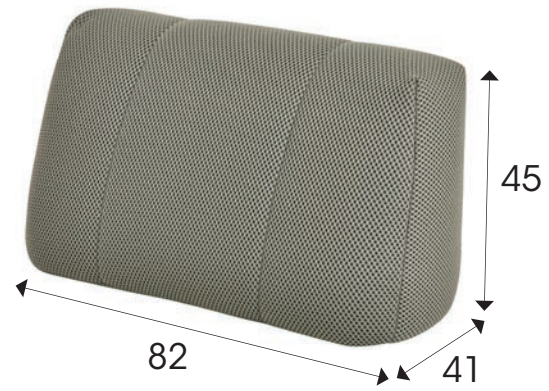

# MUSK



2 x YP1000+YR000 • Golf Grey  
2 x YP1000+YR000 • Golf Black  
1 x YP1000+YR000 • Golf Oker

MUSK = toon op toon  
= fil ton sur ton

# NUBE



F3830 • Bita Ecrú (kussens inbegrepen)

NUBE = toon op toon  
= fil ton sur ton

118

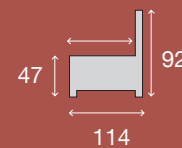
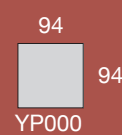
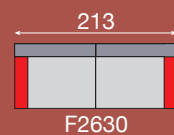
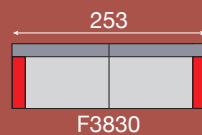

# PENELOPE



Afmetingen zie p. 120  
Dimensions p. 120

F2610+YL920  
Batch White

PENELOPE = toon op toon  
= fil ton sur ton

66



F1600

95

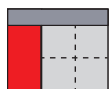

F1610

95



F1620

66

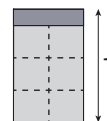

YS600

95

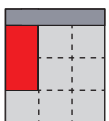

YS610

95

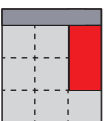

YS620

95

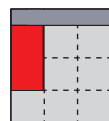

YL610

95

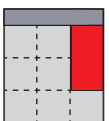

YL620

98

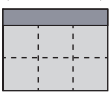

F1900

127



F1910

127

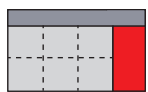

F1920

98

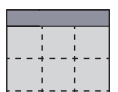

YS900

127



YS910

127



YS920

127

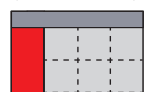

YL910

127

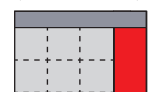

YL920

130



F2600

159

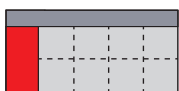

F2610

159

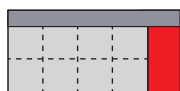

F2620

134

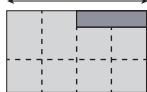

YM610

134

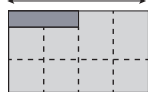

YM620

109

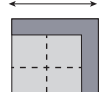

YH000

100

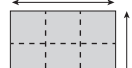

YP000

57

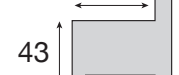

99



# PENELOPE



F2610+F1600+YH000+F2620+YP000 • Batch White  
3 x Fan30 Aris Black

PENELOPE = toon op toon  
= fil ton sur ton

# PLUMI

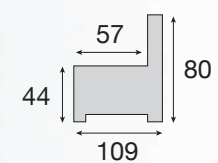
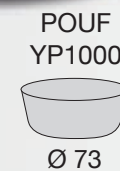
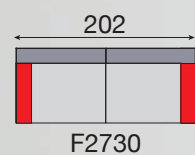
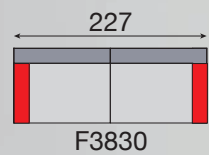
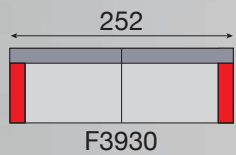

F3930+ YP000 • Dasco Pearl • Club • Bador Ecrú

PLUMI = toon op toon  
= fil ton sur ton

PLUTO = contrasterend garen  
= fil contrasté

# POLANY



DECO

3+1+P • Bost Sky / Z250

POLANY = toon op toon  
= fil ton sur ton

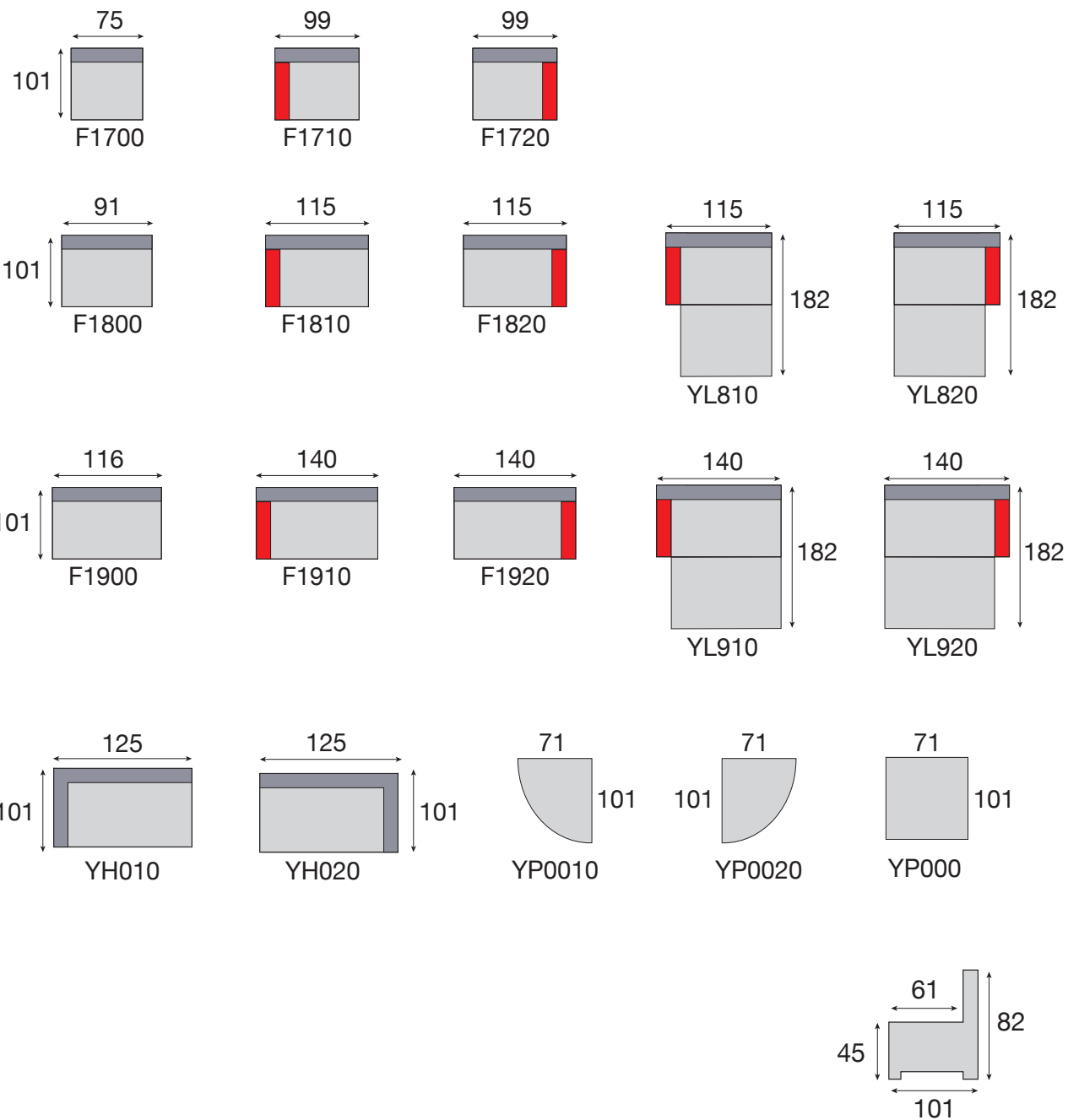

# SALTILLO



F1810+F1800+YH020+F1800+YP0020 • Dasco atlantic  
2 x Fan30 Aris Celadon

SALTILLO = toon op toon  
= fil ton sur ton

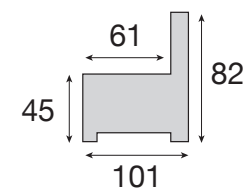
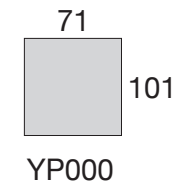
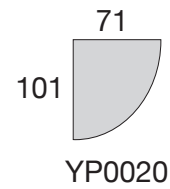
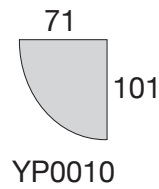
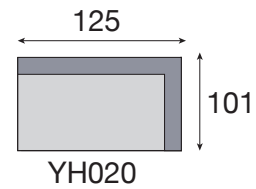
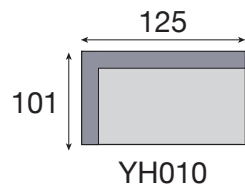
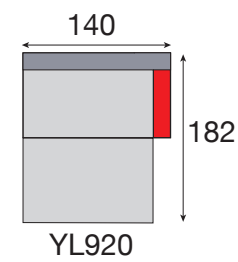
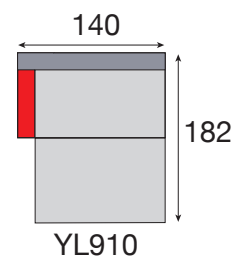
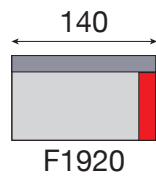
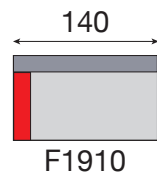
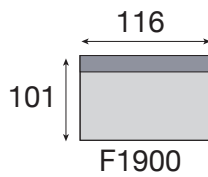
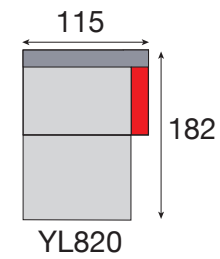
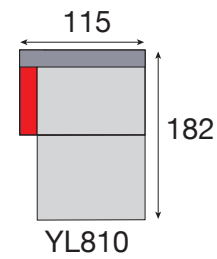
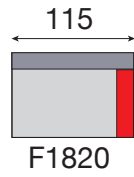
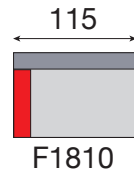
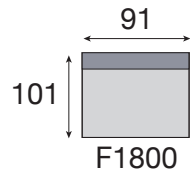
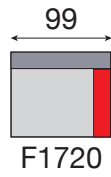
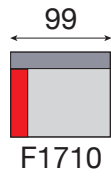
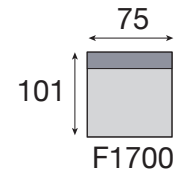

# SALTILLO



DECO

YL910+F1920 • Santa Mineral  
YP000 • Bador Niagara  
2 x Fan31 Bador Niagara

SALTILLO = toon op toon  
= fil ton sur ton

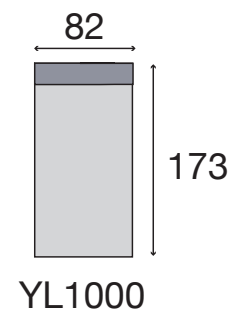
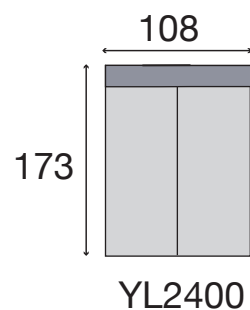
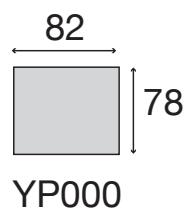
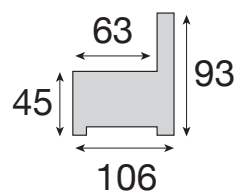
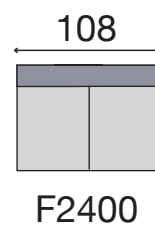
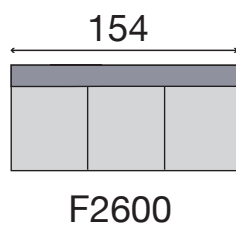
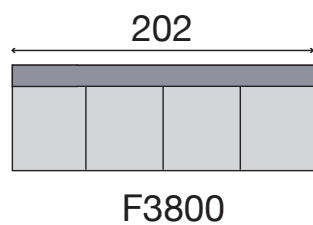



# SCALO



F2600 • Benjo Mustard  
YL2400 • Benjo Coconut  
F1000 • Benjo Orange

SCALO = toon op toon  
= fil ton sur ton

DECO

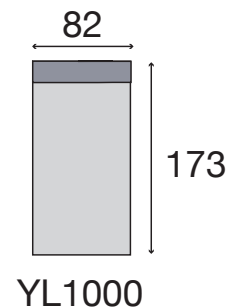
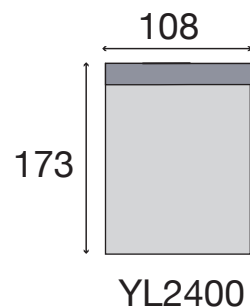
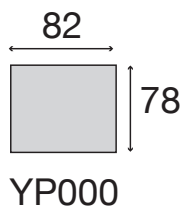
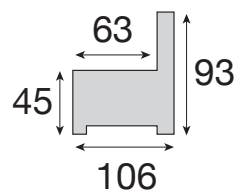
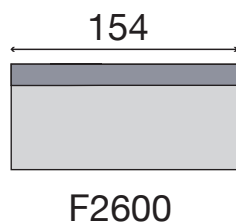
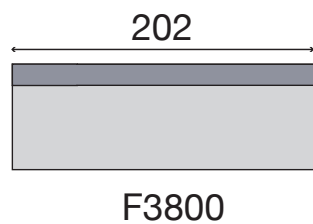

# SILANUS



DECO

F2600 • Barmon White  
YL2400 • Barmon White  
F1000 • Barmon Petrol

SILANUS = toon op toon  
= fil ton sur ton

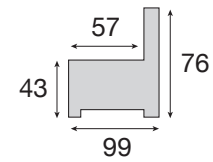
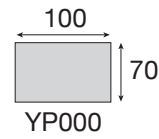
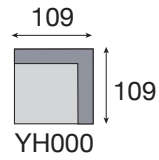
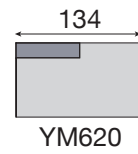
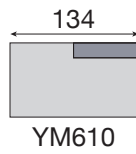
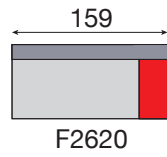
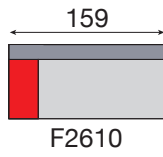
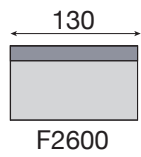
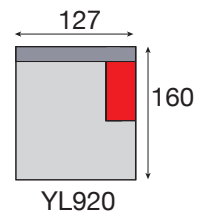
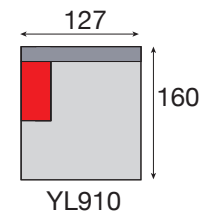
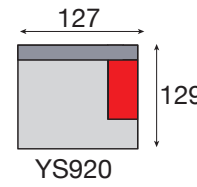
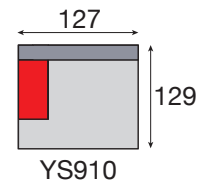
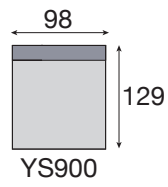
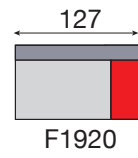
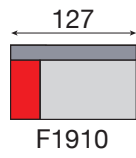
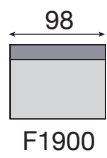
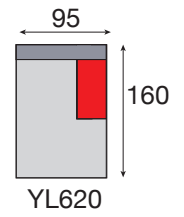
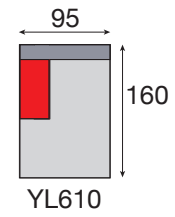
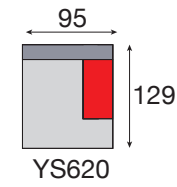
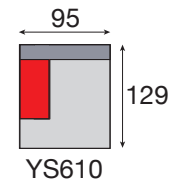
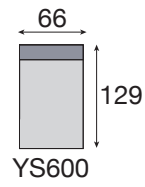
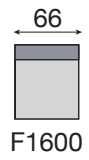

# SQUARE



ITALY Club  
Bost Forest

YL910+F2610 • Storza Forest / YP000 • Bost Forest  
2 x Fan31 Sisso Green / 2 x Fan31 Bost Forest

SQUARE = toon op toon  
= fil ton sur ton

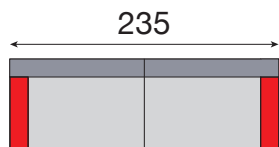

F3830

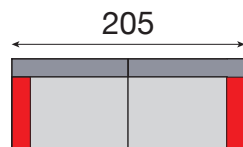

F2630

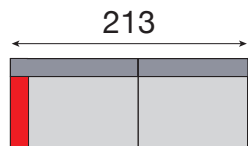

F3810

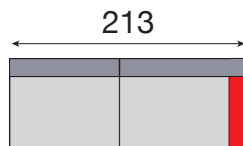

F3820

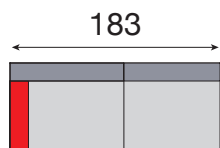

F2610

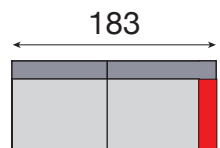

F2620

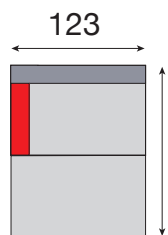

YL810

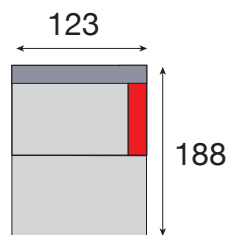

YL820

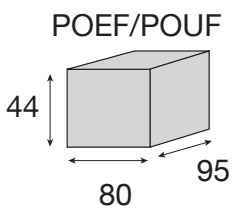
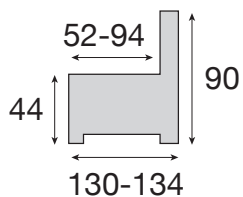

# ST GERMAIN



DECO

YL810+F3820 • Barmon Toffee

ST GERMAIN = toon op toon  
= fil ton sur ton

# TSOMO



F3830 • Bach Niagara  
F2730 • Batch Forest  
136

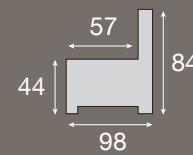
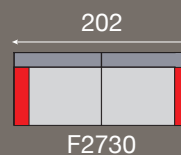
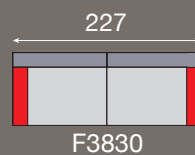
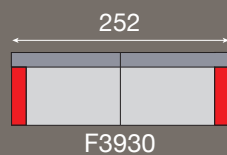

TSOMO = toon op toon  
= fil ton sur ton



# TSOMO



DECO

F3830+F2730  
Barmon White

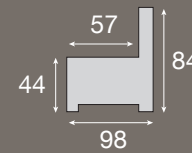
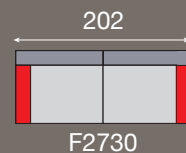
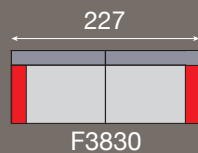
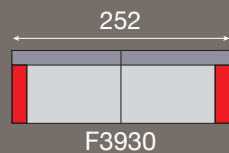

TSOMO = toon op toon  
= fil ton sur ton





CLASSIC

CLASSIC

## VAST/FIXE

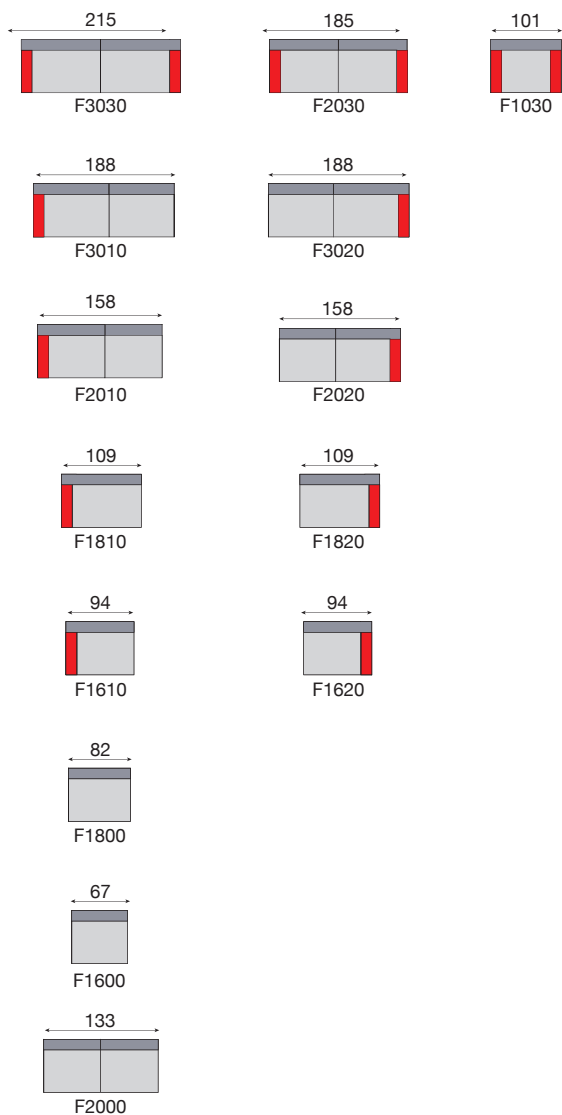

## RELAX ELEKTRISCH/ELECTRIQUE

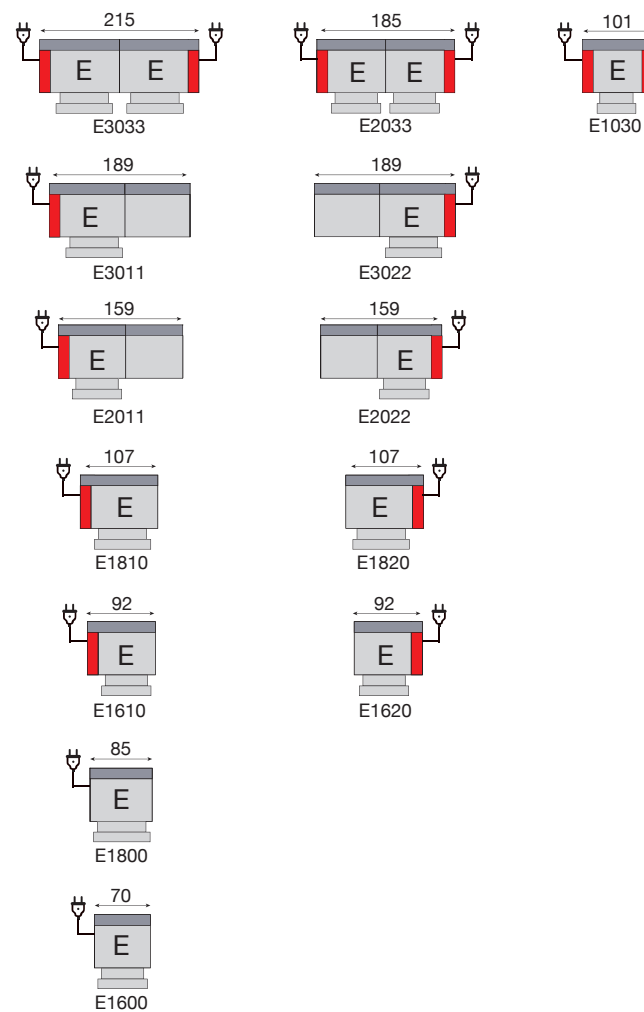

Relaxsystem  
wall-away  
Système relax  
dos-mur

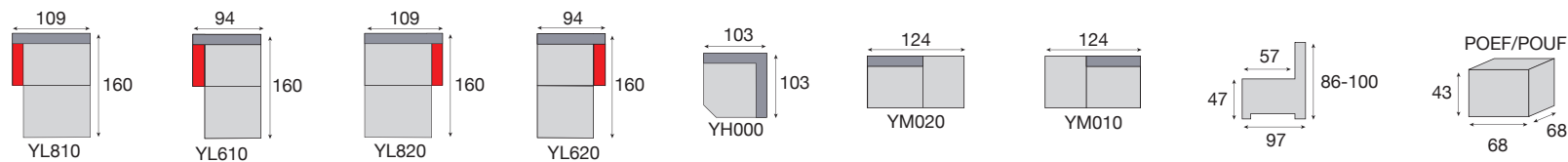

# ALICIA



E1810+E1800+YH000+YM020  
Bepal Darkgrey/CF100

ADELE = toon op toon  
= fil ton sur ton

ALICIA = contrasterend garen  
= fil contrasté



## VAST/FIXE

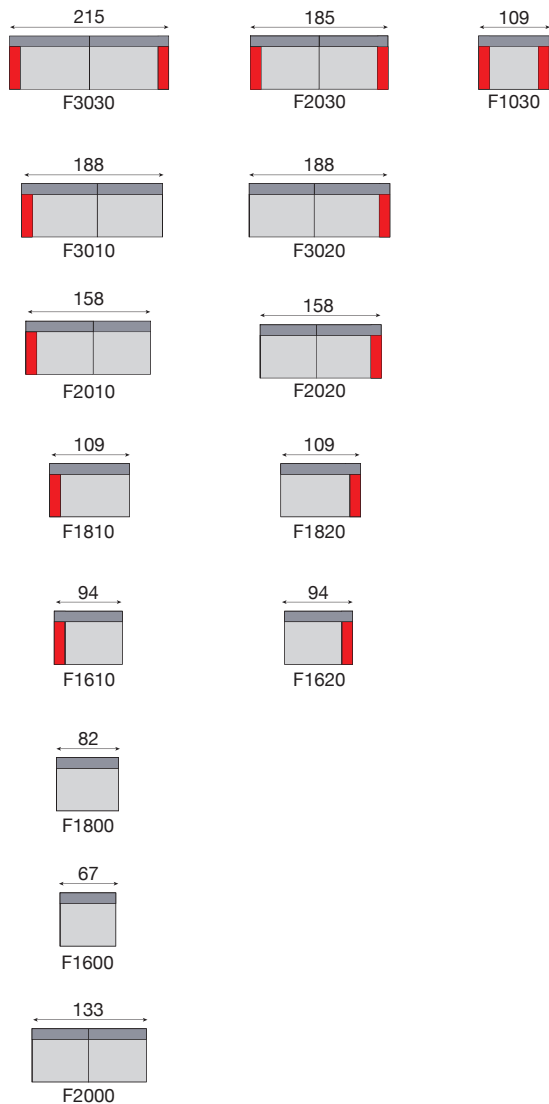

## RELAX ELEKTRISCH/ELECTRIQUE

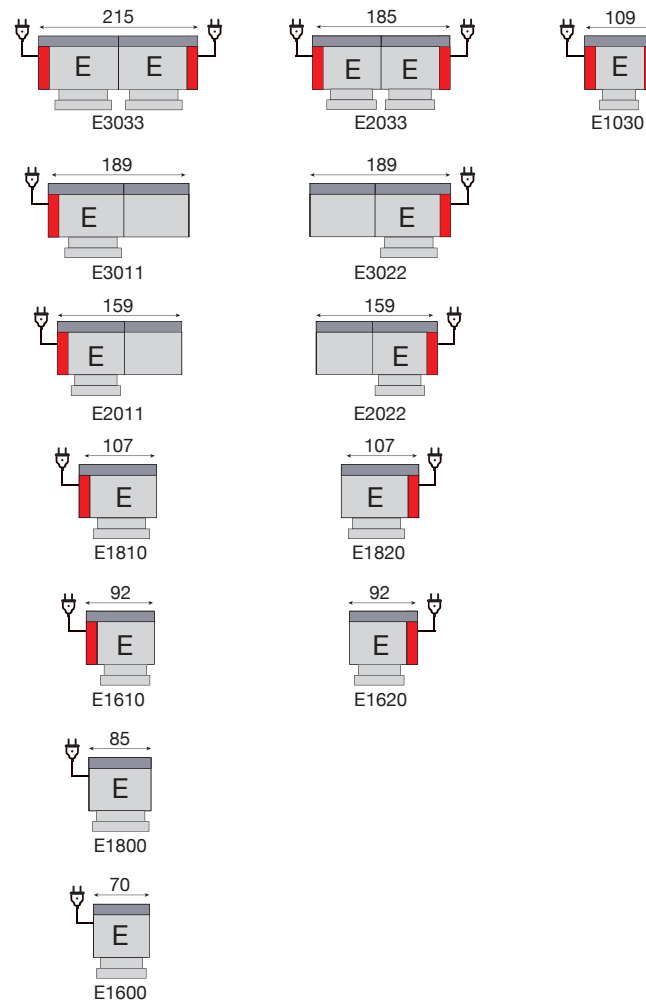

Relaxsystem  
wall-away  
Système relax  
dos-mur

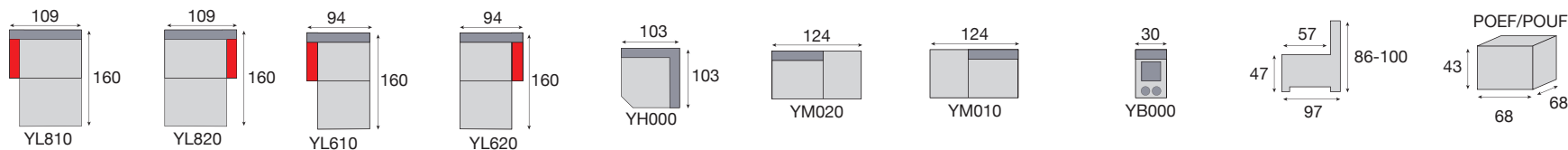

# ANAIS



YL810+E1800+E1800+YH000+F3020 • Colo Taupe/Chroom  
3 x Fan14 Colo Brown



ALANA = toon op toon  
= fil ton sur ton

ANAIS = contrasterend garen  
= fil contrasté

143

## VAST/FIXE

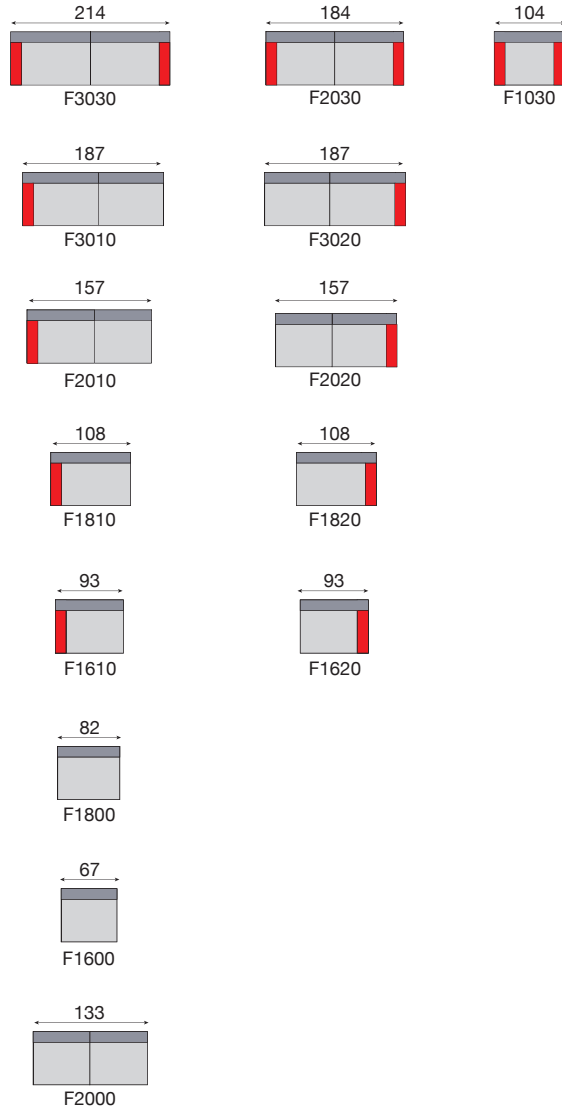

## RELAX ELEKTRISCH/ELECTRIQUE

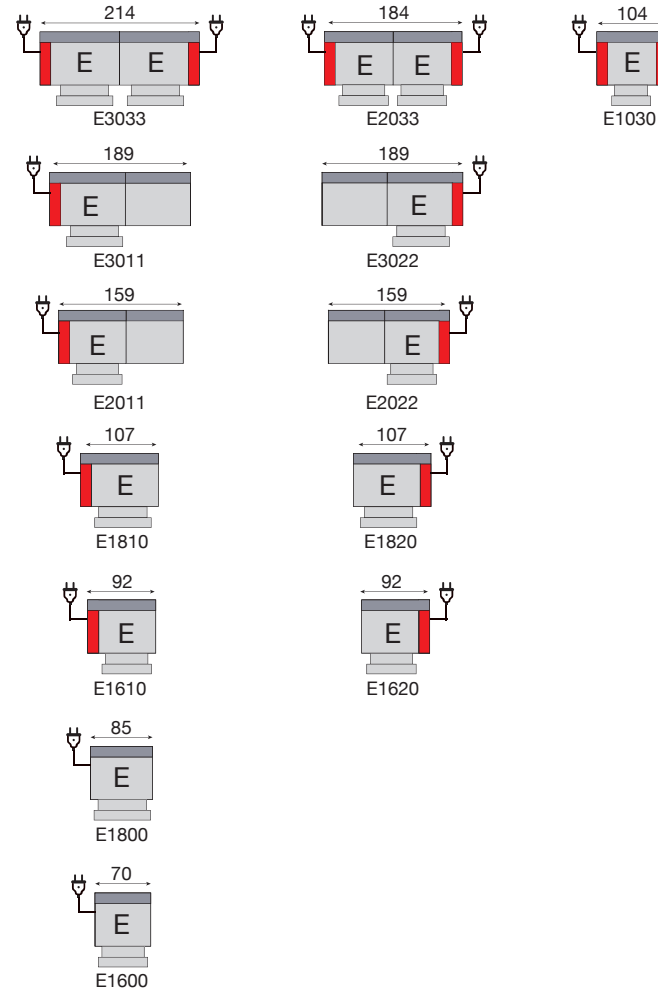

Relaxsystem  
wall-away  
Système relax  
dos-mur

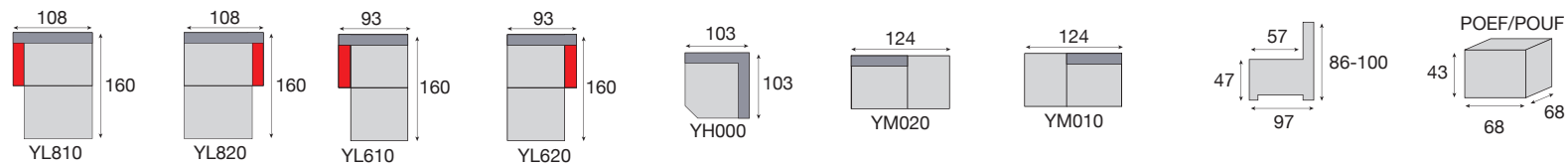



# BALCONY



YL810+E1800+E1800+YH000+F3020 • Sisso Cognac

BOLLINI = toon op toon  
= fil ton sur ton

BALCONY = contrasterend garen  
= fil contrasté



145

## VAST/FIXE

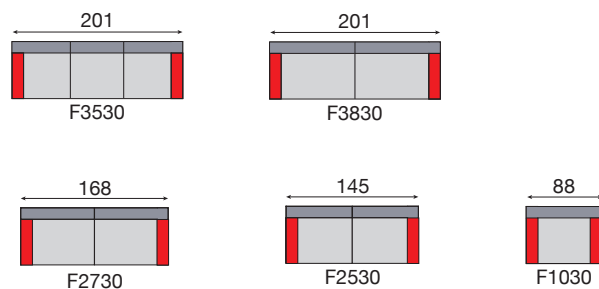

## RELAX ELEKTRISCH/ELECTRIQUE

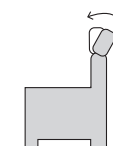
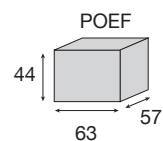
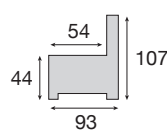
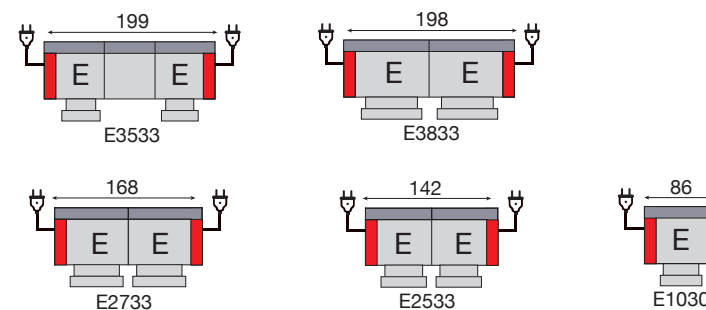

enkel in relax versie  
uniquement  
en version relax

# CHIVOR



E3533+F2530 • Bannel Silver  
E1030 • Ago Silver  
2 x Fan31 Batch Sand



CHIVOR = contrasterend garen  
= fil contrasté

CORRY = toon op toon  
= fil ton sur ton

Kleur 1 = massa  
 Kleur 2 = bias (detail)

Couleur 1 = masse  
 Couleur 2 = passepoile (détail)

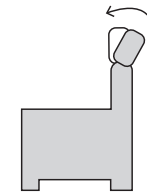
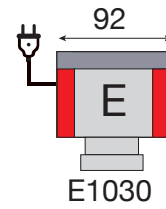
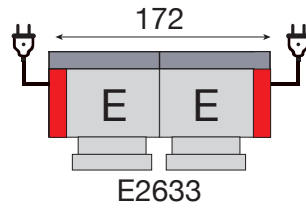
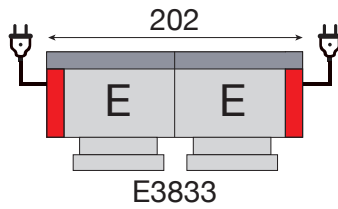
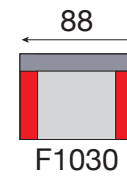
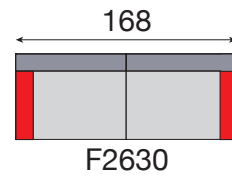
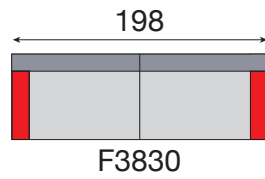

Manuele  
 hoofdsteun  
 (E codes)

Appui-têtes  
 manuelles  
 (codes E)

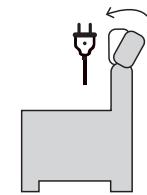
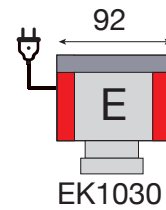
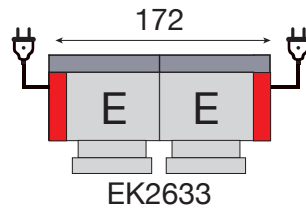
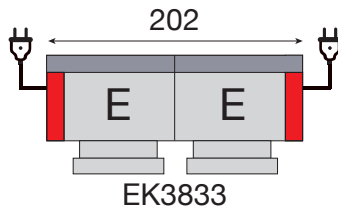

Elektrische  
 hoofdsteun  
 (EK codes)

Appui-têtes  
 électriques  
 (codes EK)

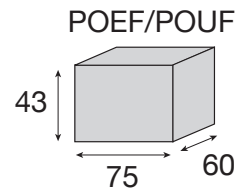
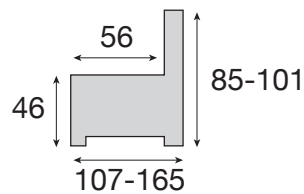

# DRESDEN



EK3833+F2630 • Santa Blue + Santa Black  
2 x Fan31 Aris Deepblue

DRESDEN = toon op toon  
= fil ton sur ton

## VAST/FIXE



## RELAX MANUEEL/MANUEL

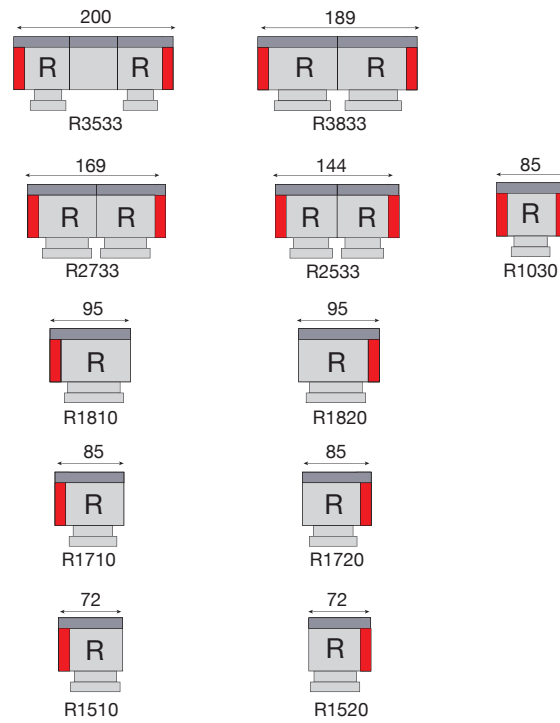

## RELAX ELEKTRISCH/ELECTRIQUE

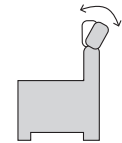
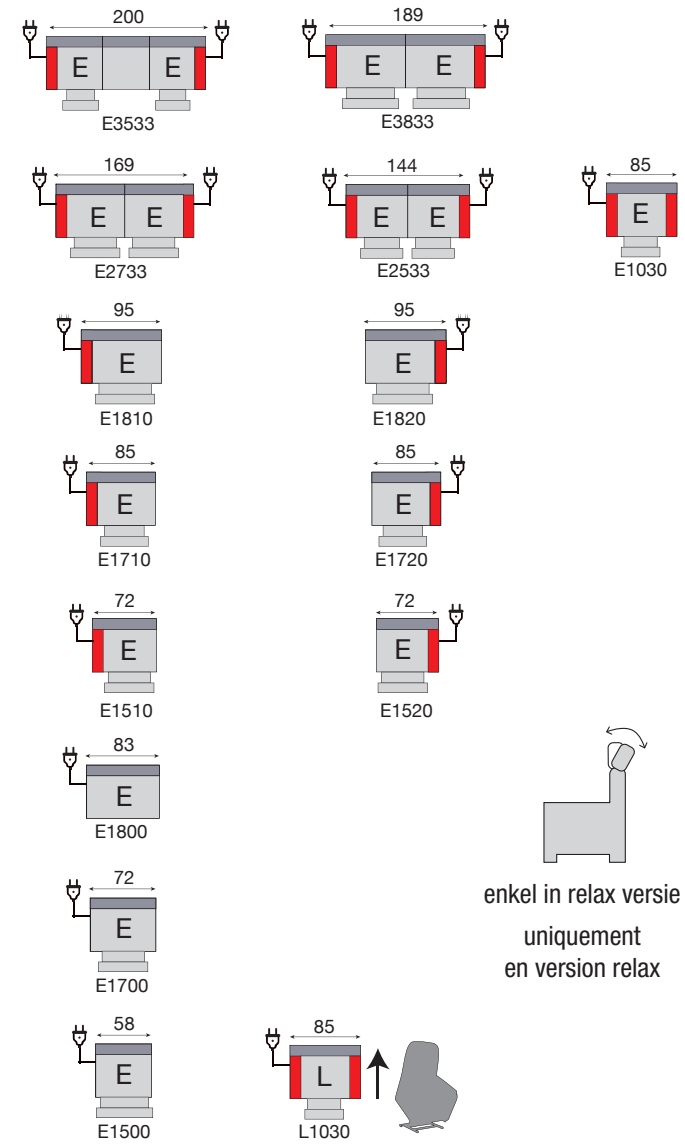

enkel in relax versie  
uniquement  
en version relax

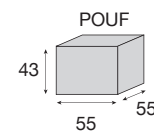
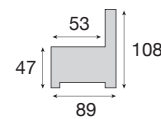
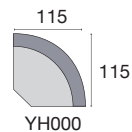

# ELYSEE

Jacques poef  
Boxfor Anis



F3530+L1030 • Barillo Antraciet  
Fan31 Aris Colombe

EMYLE = toon op toon  
= fil ton sur ton

ELYSEE = contrasterend garen  
= fil contrasté



151

## VAST/FIXE



## RELAX ELEKTRISCH/ELECTRIQUE

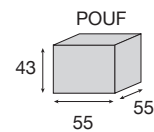
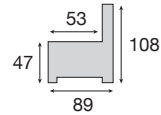
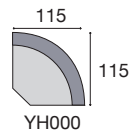
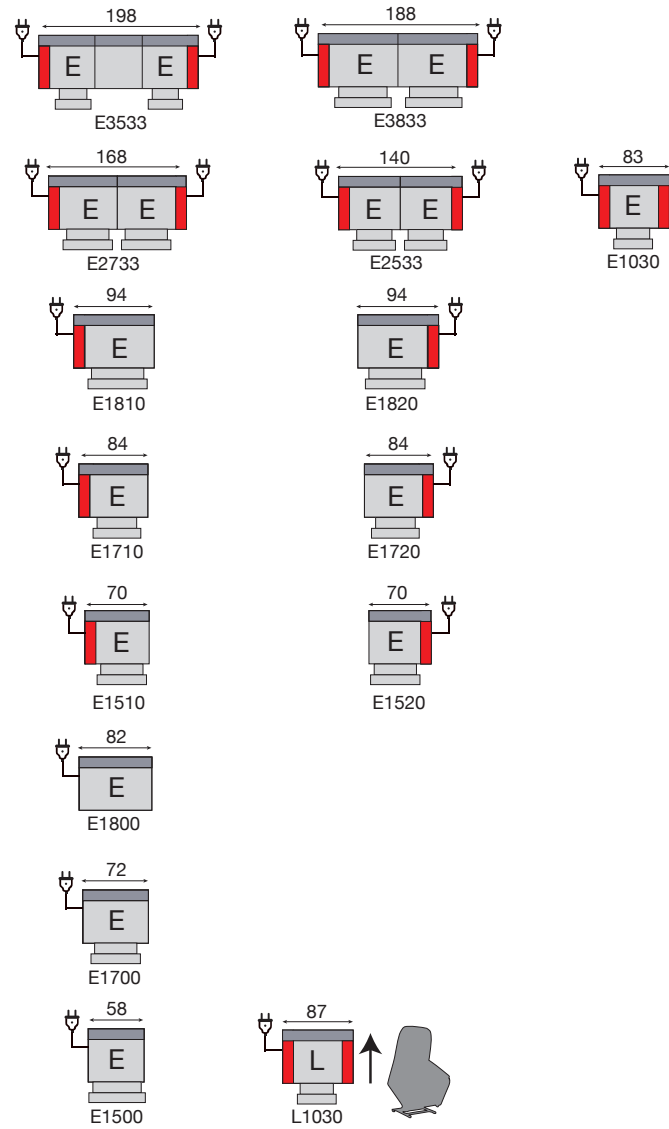

Relaxsystem  
wall-away  
Système relax  
dos-mur



# GIORGIA



E3533+F2530 • Barillo Antraciet  
L1030 • Bacif Ash

GEPETTO = toon op toon  
= fil ton sur ton

GIORGIA = contrasterend garen  
= fil contrasté



153

## VAST/FIXE



## RELAX ELEKTRISCH/ELECTRIQUE

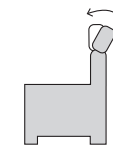
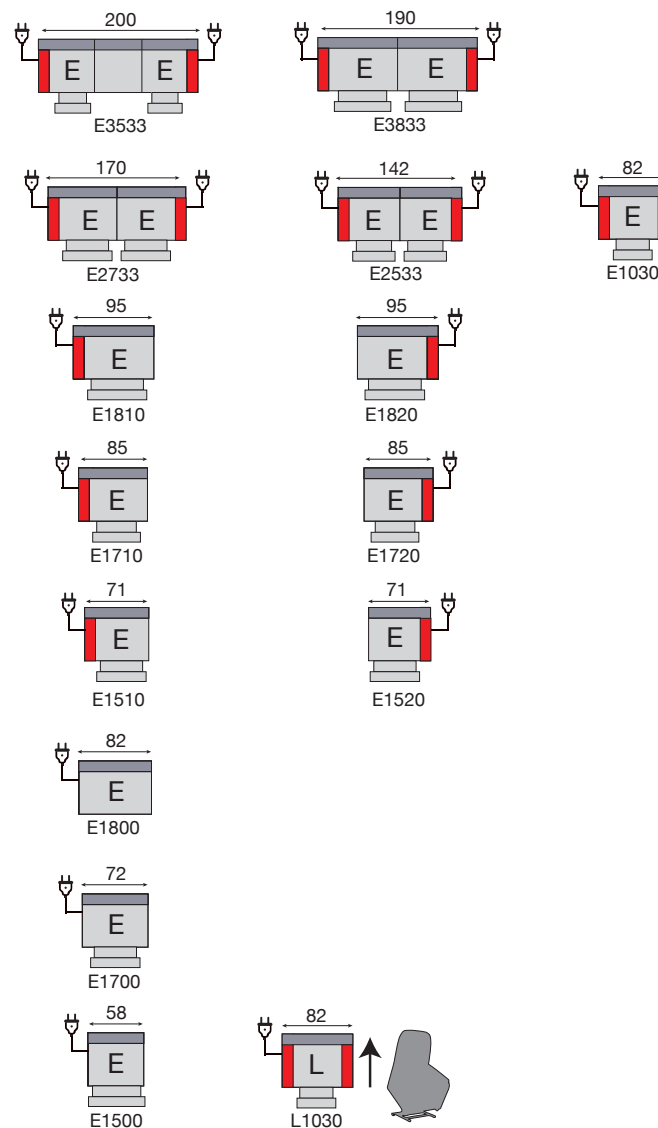

enkel in relax versie  
uniquement  
en version relax

Relaxstelsysteem  
wall-away  
Système relax  
dos-mur

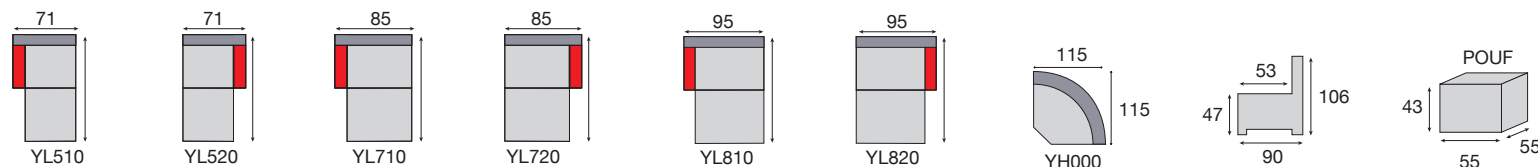

# GISSI



YL710+E1700+E1720+F2530 • Bacif Mouse

2 x Fan31 Colo Oldrose  
2 x Fan31 Aris Salmon

GUSTO = toon op toon  
= fil ton sur ton

GISSI = contrasterend garen  
= fil contrasté



155

CLASSIC

## VAST/FIXE

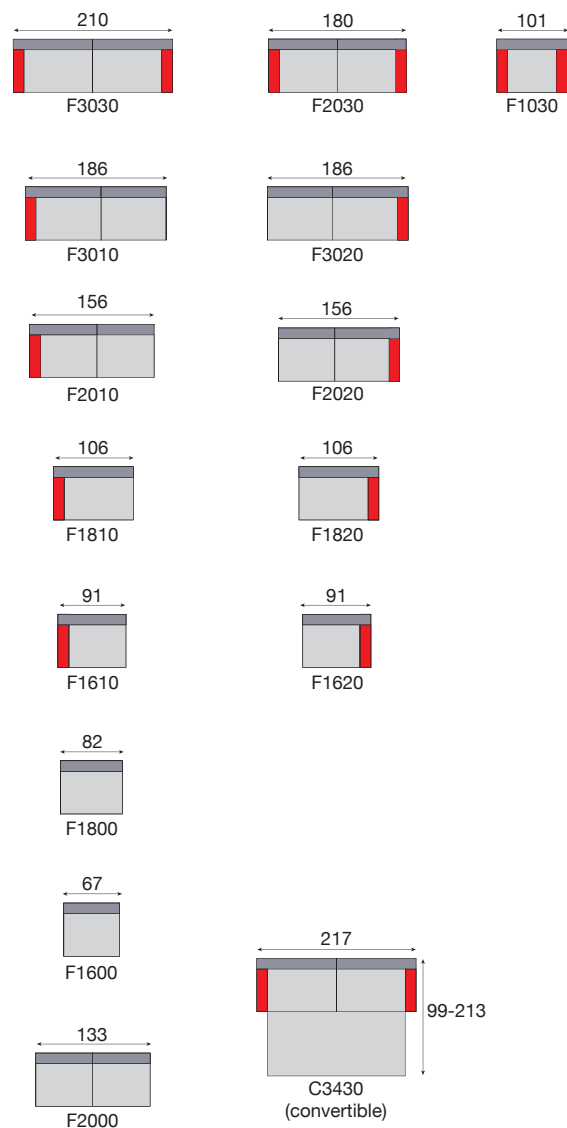

## RELAX ELEKTRISCH/ELECTRIQUE

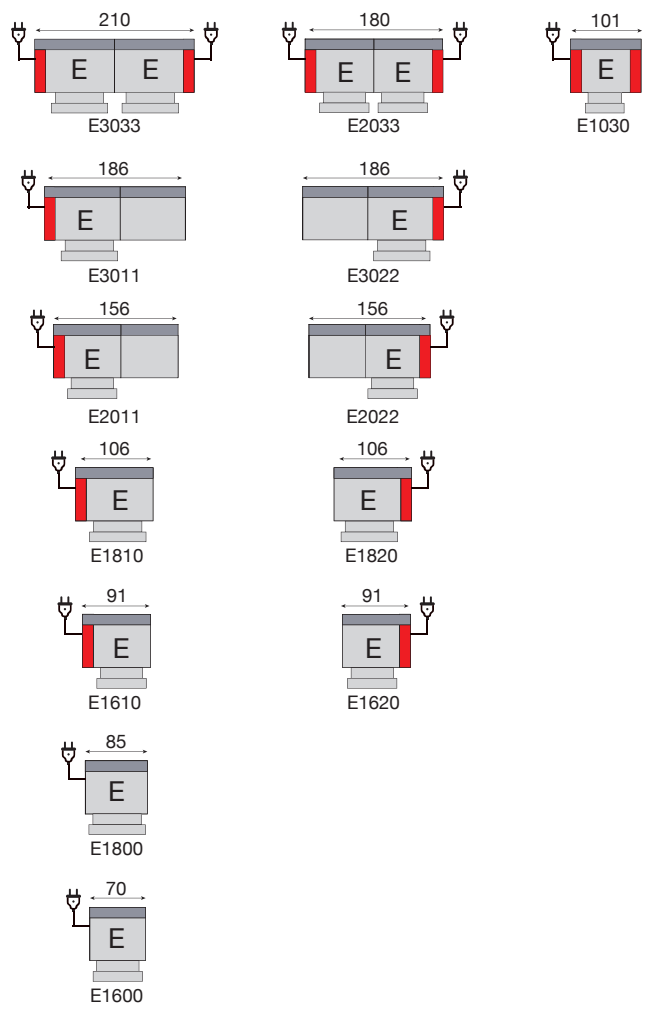

Relaxsystem  
wall-away  
Système relax  
dos-mur

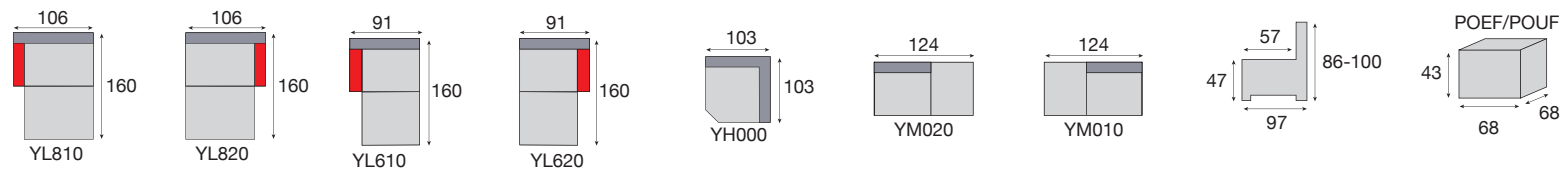

# LORE



E3033+F2030 • Belux Steel/CF100

LIZZY = toon op toon  
= fil ton sur ton

LORE = contrasterend garen  
= fil contrasté

157

## VAST/FIXE

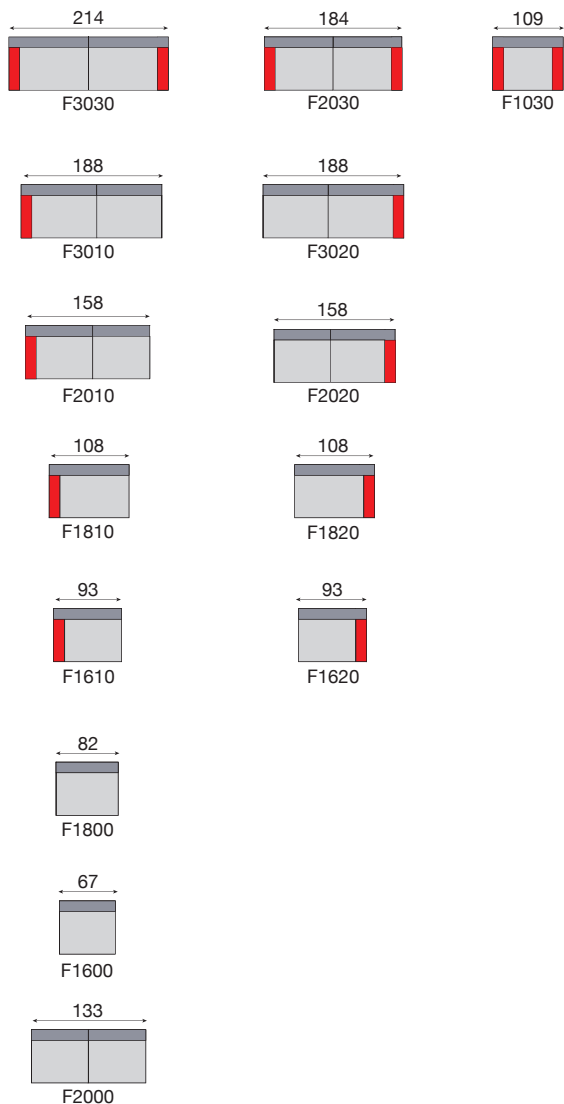

## RELAX ELEKTRISCH/ELECTRIQUE

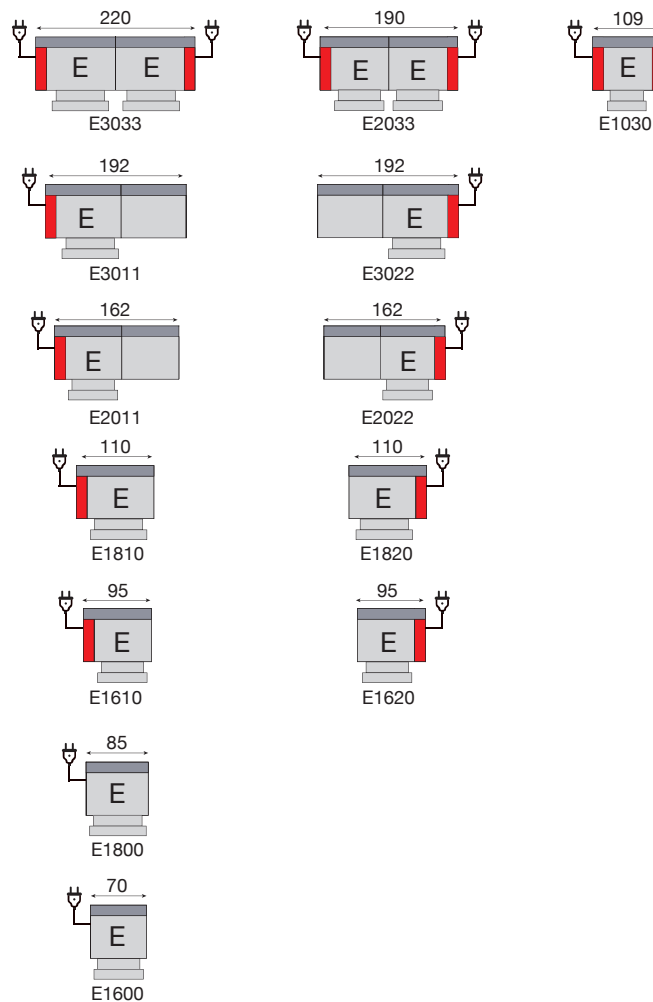

Relaxsystem  
wall-away  
Système relax  
dos-mur

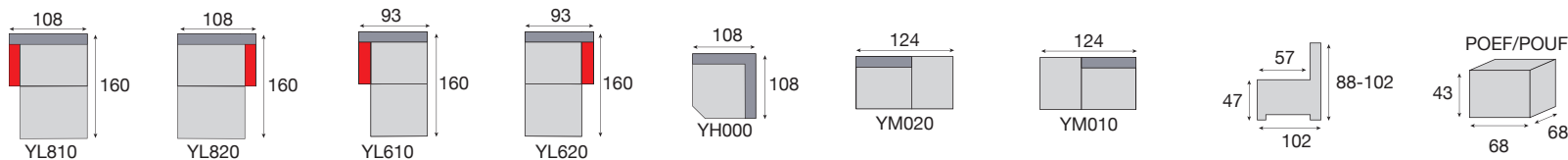

# MANDY



YL810+E1800+E1800+YH000+F3020 • Bacif Mouse

2 x Fan31 Bicas Aubergine / Fan31 Aris Aubergine  
Bob Bicas Aubergine / Bobette Aris Aubergine

MANDY = toon op toon  
= fil ton sur ton

MALLORCA = contrasterend garen  
= fil contrasté



159

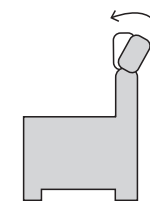
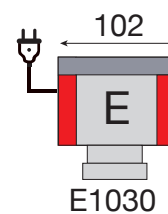
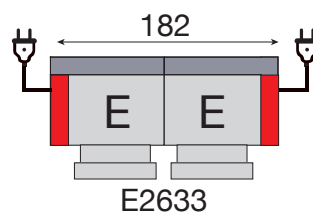
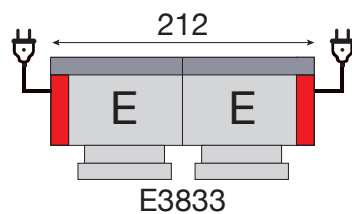
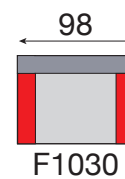
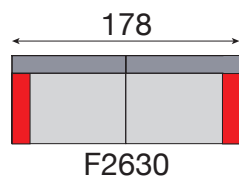
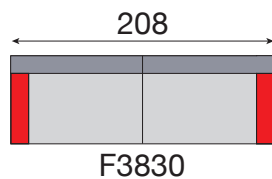

Manuele hoofdsteen  
Appui-têtes manuelles  
(codes E)

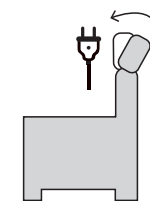
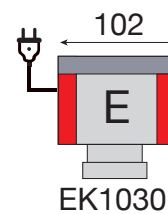
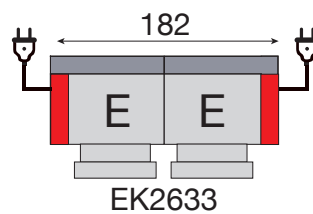
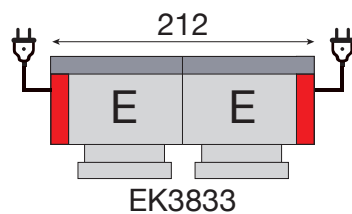

Elektrische hoofdsteen  
Appui-têtes électriques  
(codes EK)

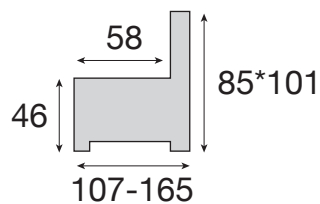

Relaxsystem  
wall-away  
Système relax  
dos-mur





# MARTHA



E3833+F2630 • Busion Steel  
2 x Fan31 Bador Darkgrey

MARTHA = toon op toon  
= fil ton sur ton

CLASSIC

## VAST/FIXE

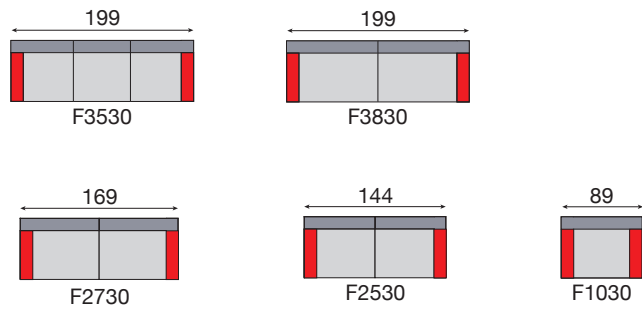

## RELAX ELEKTRISCH/ELECTRIQUE

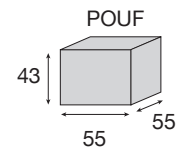
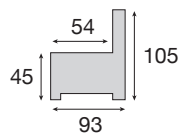
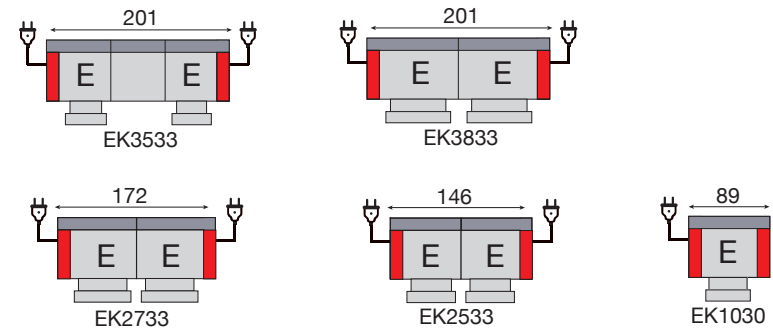

Relaxsystem  
wall-away  
Système relax  
dos-mur

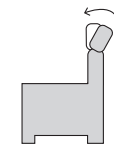

elektrische hoofdsteen  
enkel in relax versie  
tête électrique  
uniquement  
en version relax

# MERLOT



EK3533+EK1030 • Bacif Darkgrey

MEDOC = toon op toon  
= fil ton sur ton

MERLOT = contrasterend garen  
= fil contrasté

163

## VAST / FIXE

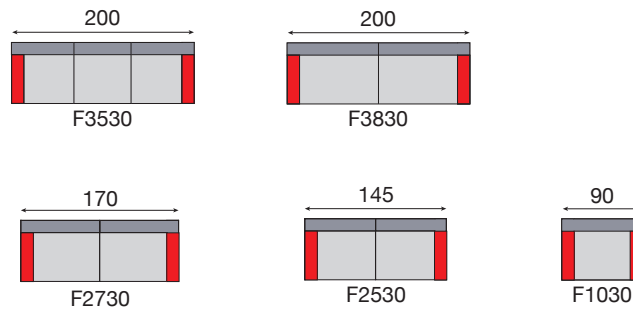

## RELAX ELEKTRISCH / ELECTRIQUE

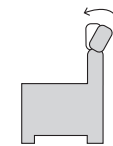
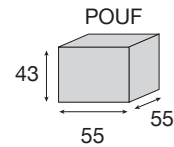
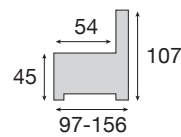
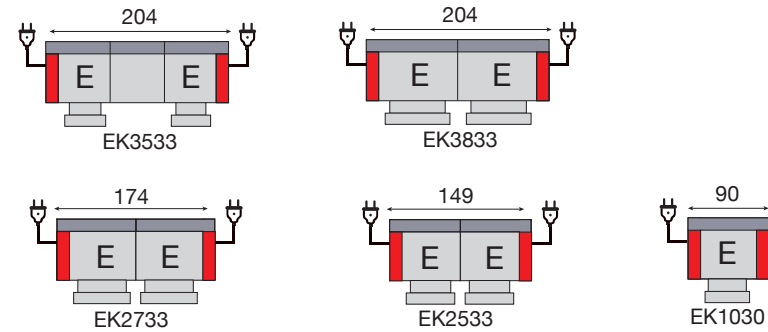

Relaxstelsysteem  
wall-away  
Système relax  
dos-mur

elektrische hoofdsteen  
enkel in relax versie  
tête électrique  
uniquement  
en version relax

# MINEROS



EK3533+EK1030 • Santa Falcon

MINEROS = contrasterend garen  
= fil contrasté

165

CLASSIC

## VAST/FIXE

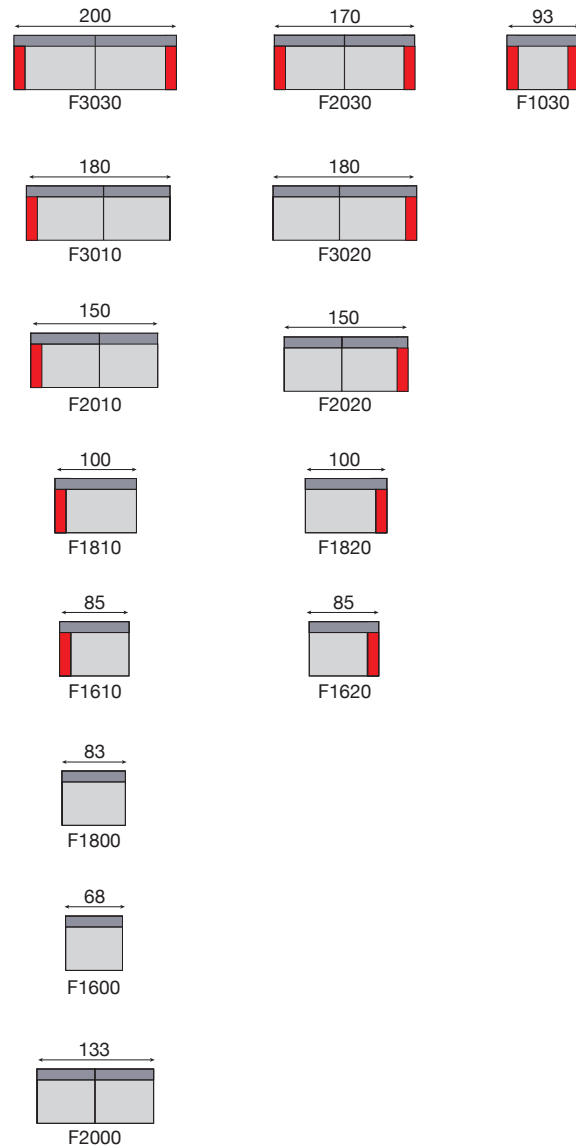

## RELAX ELEKTRISCH/ELECTRIQUE

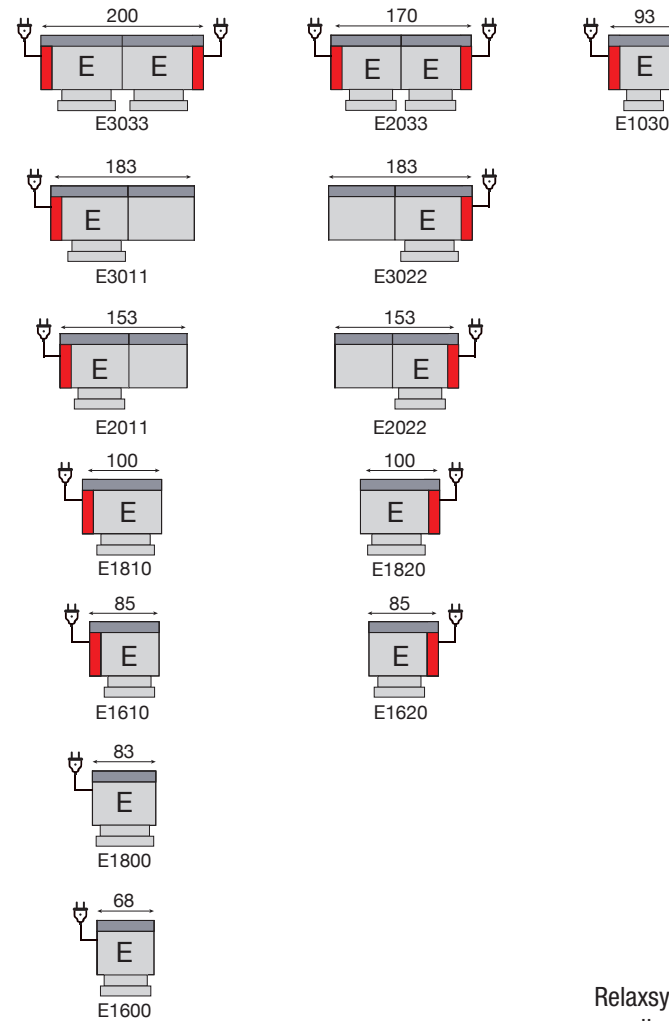

Relaxsystem  
wall-away  
Système relax  
dos-mur

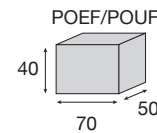
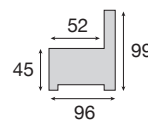
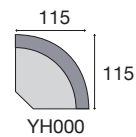

# ORTONA



CALINE Club  
Bagen Orange +  
Bontan Vison

E3033+F2030 • Bontan Vison

2 x Fan31 Bagen Orange  
2 x Fan31 Box Terracotta

ORTONA = toon op toon  
= fil ton sur ton

OMODA = contrasterend garen  
= fil contrasté



167

## VAST/FIXE



## RELAX ELEKTRISCH/ELECTRIQUE

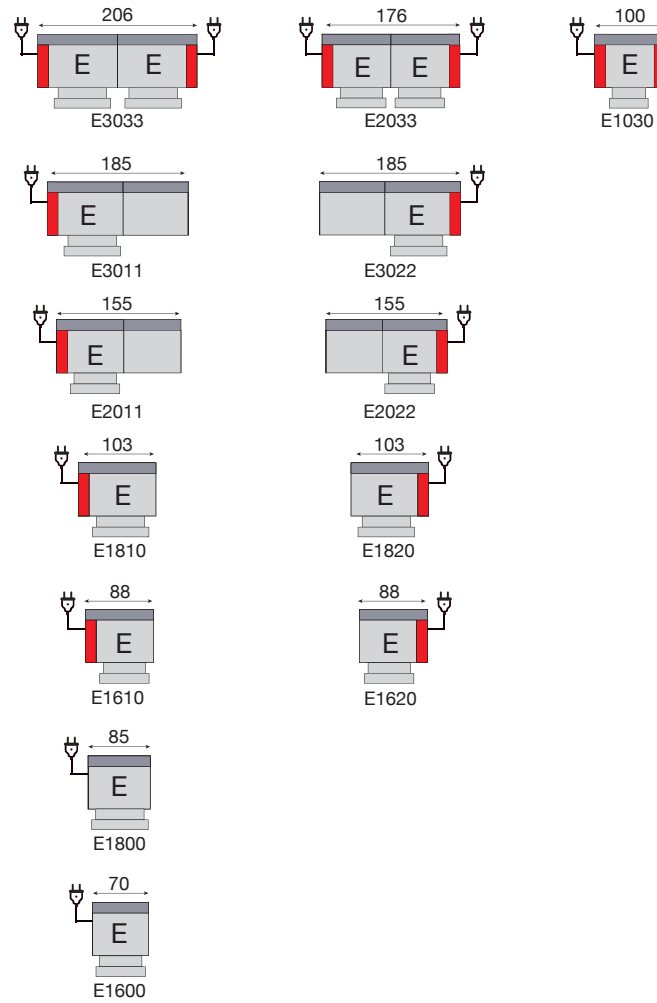

Relaxsystem  
wall-away  
Système relax  
dos-mur

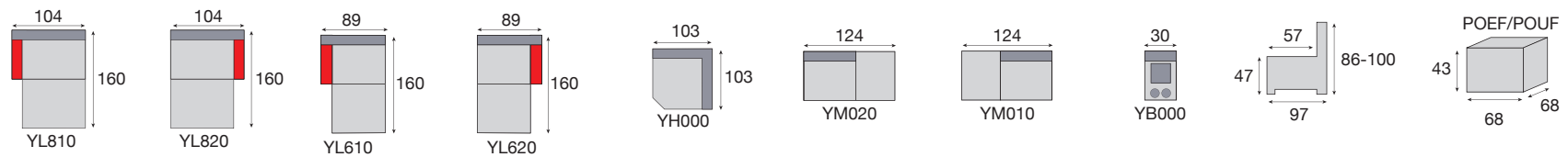



# PANENKA



YL810+E1800+E1820 • Colo Taupe  
CF100



PANENKA = toon op toon  
= fil ton sur ton

PANAMERA = contrasterend garen  
= fil contrasté

169

CLASSIC

## VAST/FIXE



## RELAX MANUEEL/MANUEL

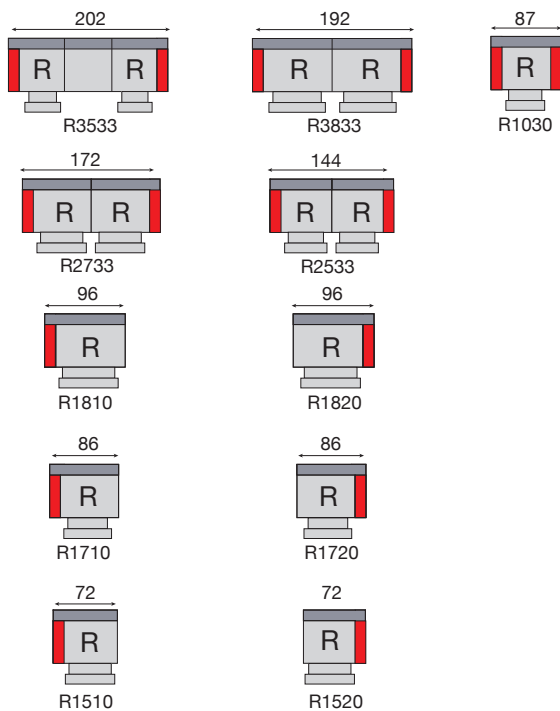

## RELAX ELEKTRISCH/ELECTRIQUE

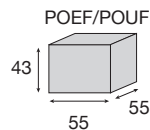
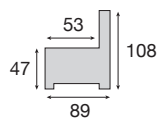
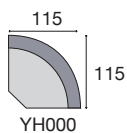
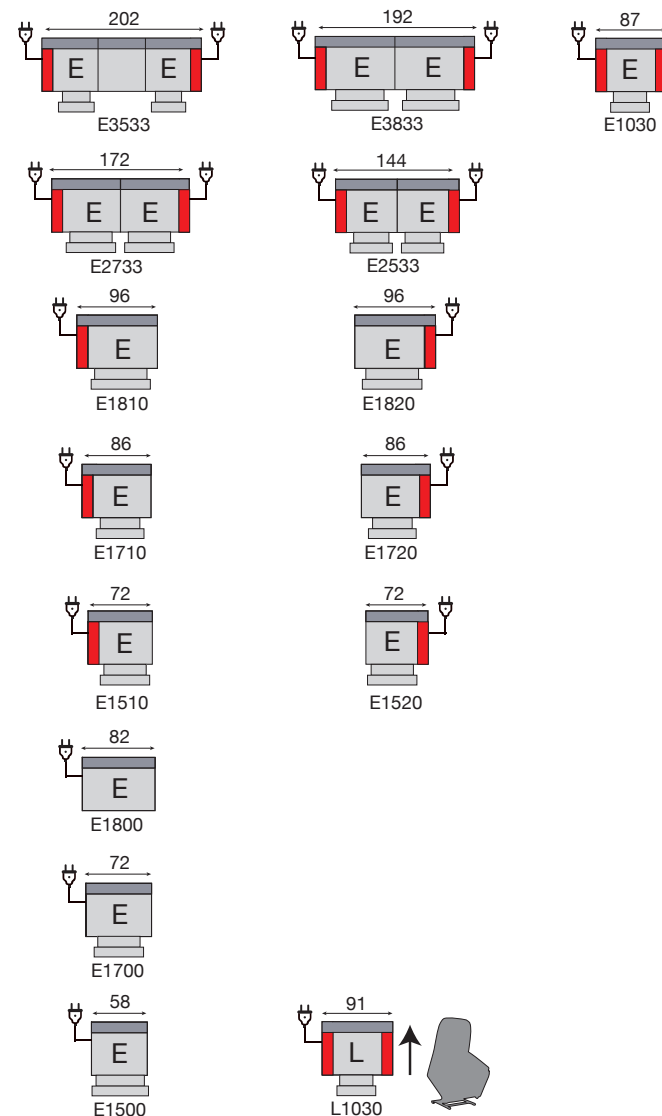

# PAUL



E3533+F2530 • Bibuk Elephant

PAULETTE = toon op toon  
= fil ton sur ton

PAUL = contrasterend garen  
= fil contrasté

171

# SANDY

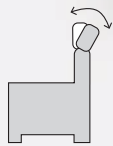

enkel in relax versie  
uniquement  
en version relax

Jacques poef  
Aris Lightgrey

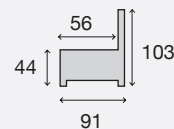
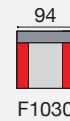
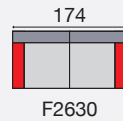
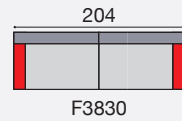
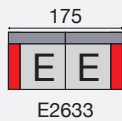
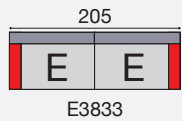

Relaxstelsysteem  
wall-away  
Système relax  
dos-mur



E3833+F2630 • Barillo Antraciet

Fan30 Aris Lightgrey  
Fan31 Aris Lightgrey

SYNTRO = toon op toon  
= fil ton sur ton

SANDY = contrasterend garen  
= fil contrasté

# SANDY

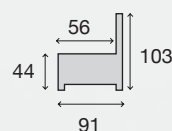
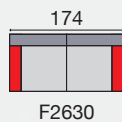
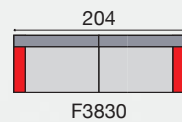
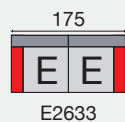
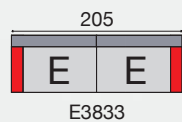

Relaxstelsysteem  
wall-away  
Système relax  
dos-mur

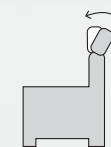

enkel in relax versie  
uniquement  
en version relax

E3833+F2630 • Bacif Taupe

2 x Fan30 Aris Negre  
Fan31 Aris Negre

SYNTRO = toon op toon  
= fil ton sur ton

SANDY = contrasterend garen  
= fil contrasté

## VAST / FIXE

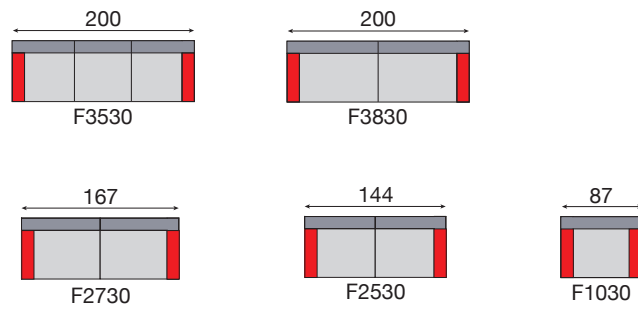

## RELAX ELEKTRISCH / ELECTRIQUE

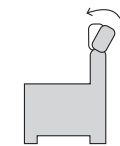
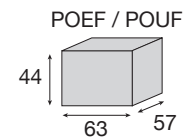
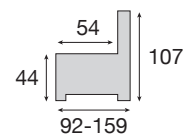
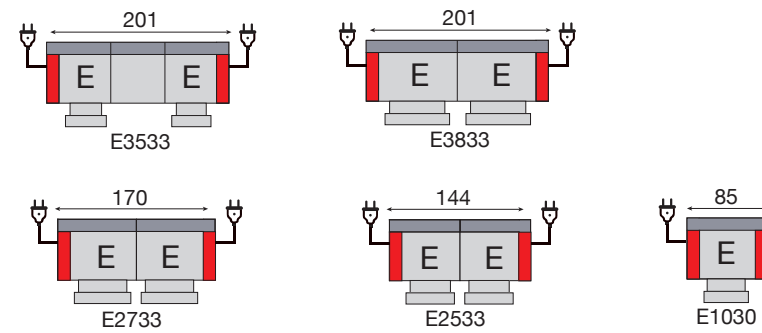

elektrische hoofdsteun  
enkel in relax versie  
tête électrique  
uniquement  
en version relax

# SORSO



E3833+F2530+E1030 • Bepal Lightgrey

SORSO = toon op toon  
= fil ton sur ton

## VAST/FIXE



## RELAX ELEKTRISCH/ELECTRIQUE

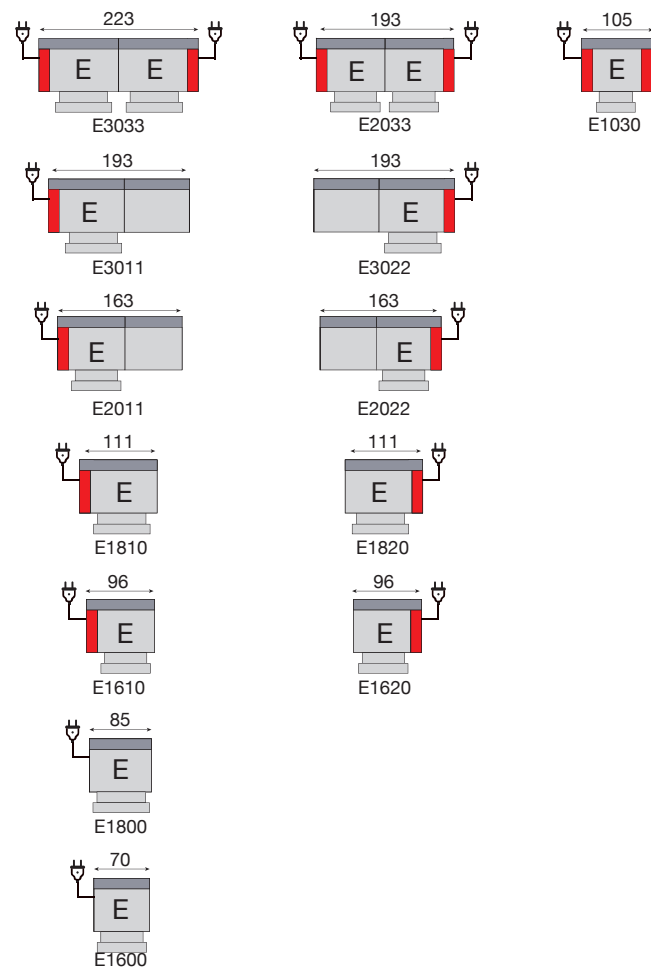

Relaxsystem  
wall-away  
Système relax  
dos-mur

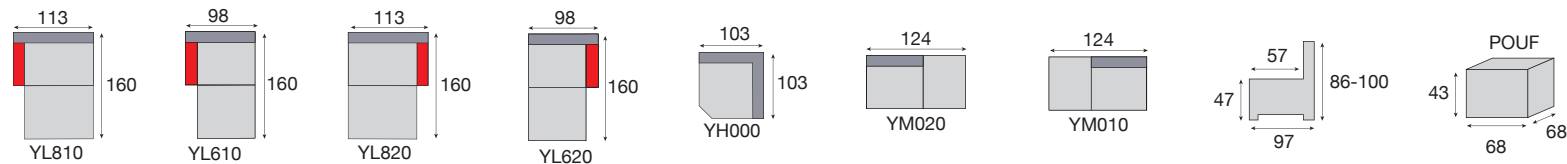



# THARA



E3033+E2033 • Consul Topic Grigio/Chroom

THARA = toon op toon  
= fil ton sur ton

THEO = contrasterend garen  
= fil contrasté

177

## BOUW UW SALON VOLLEDIG NAAR EIGEN KEUZE COMPOSEZ VOTRE SALON A VOLONTE

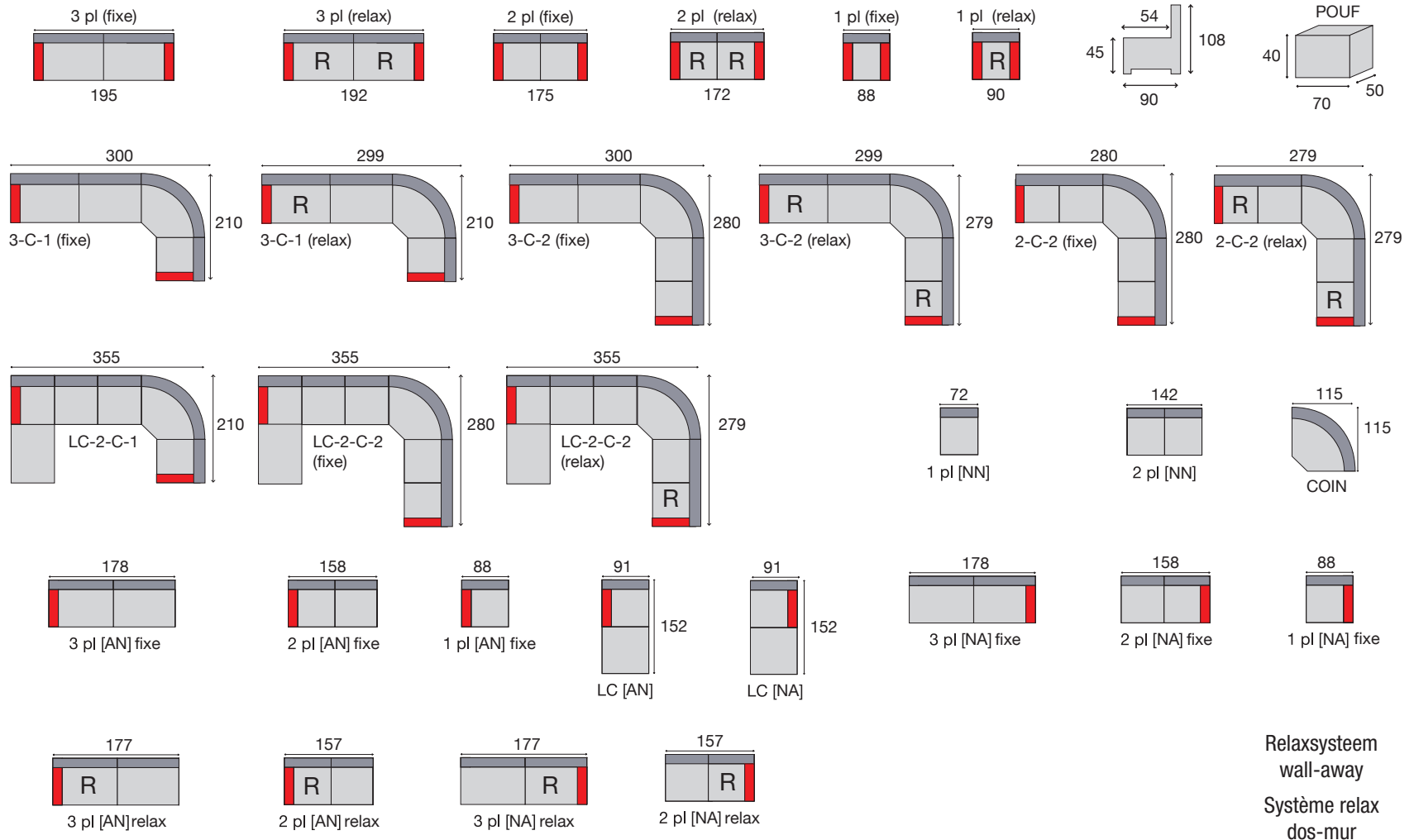

Relaxsystem  
wall-away  
Système relax  
dos-mur

# THORGAL



3+1E • Ago Darkgrey



THORGAL = toon op toon  
= fil ton sur ton

179

CLASSIC

## VAST/FIXE



## RELAX ELEKTRISCH/ELECTRIQUE

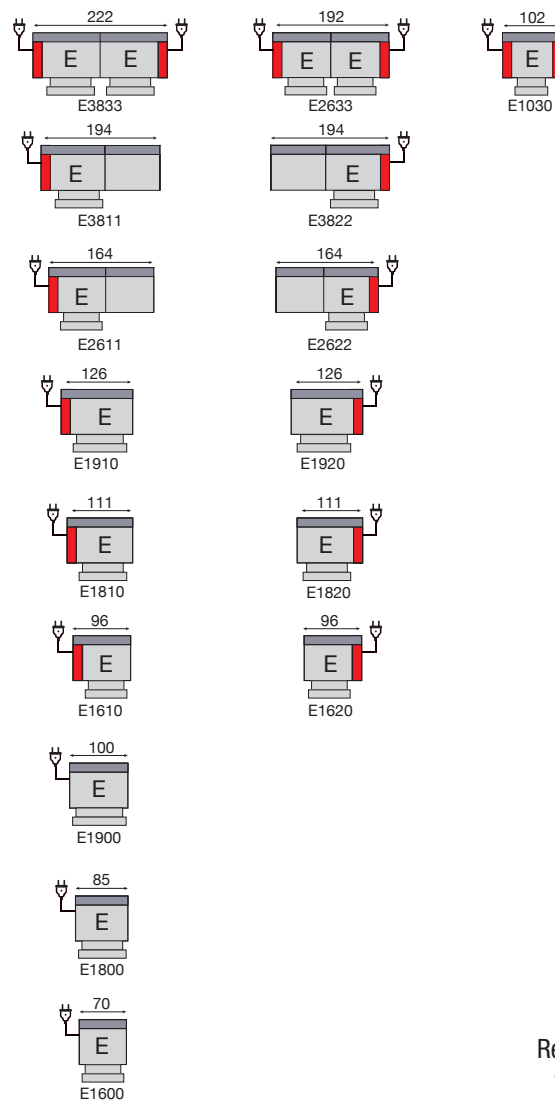

Relaxsystem  
wall-away  
Système relax  
dos-mur

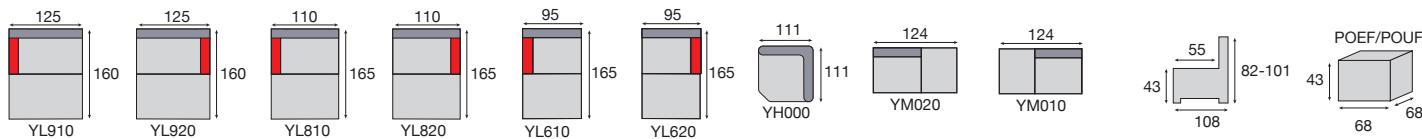

# TREK



CLASSIC

E3833+F2630 • Beskin Silver  
4 x Fan31 Aris Deepblue

TREK = toon op toon  
= fil ton sur ton





EXCLUSIVE

EXCLUSIVE

## VAST/FIXE

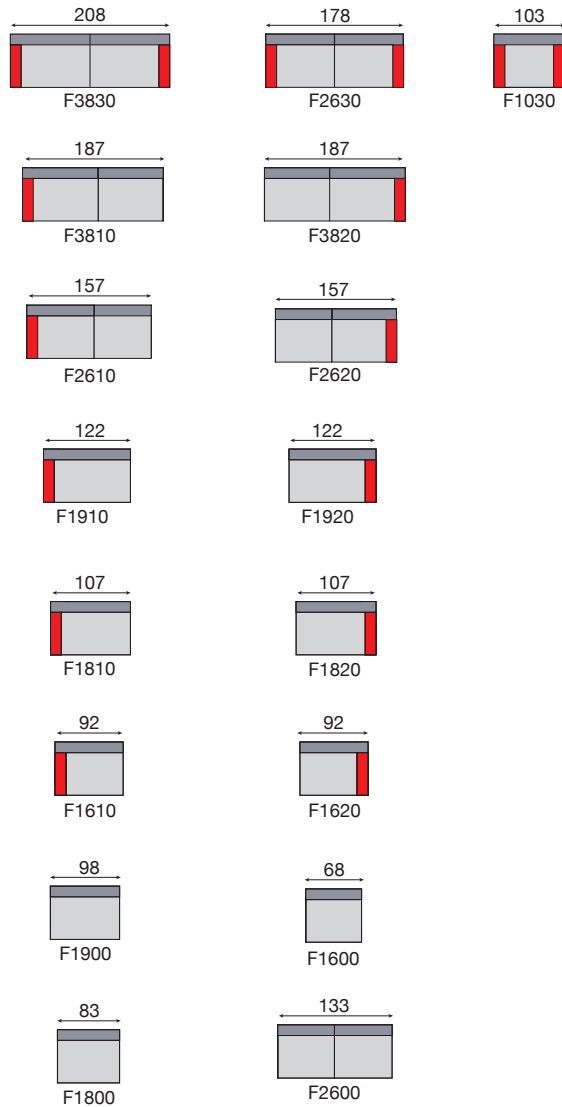

## RELAX ELEKTRISCH/ELECTRIQUE

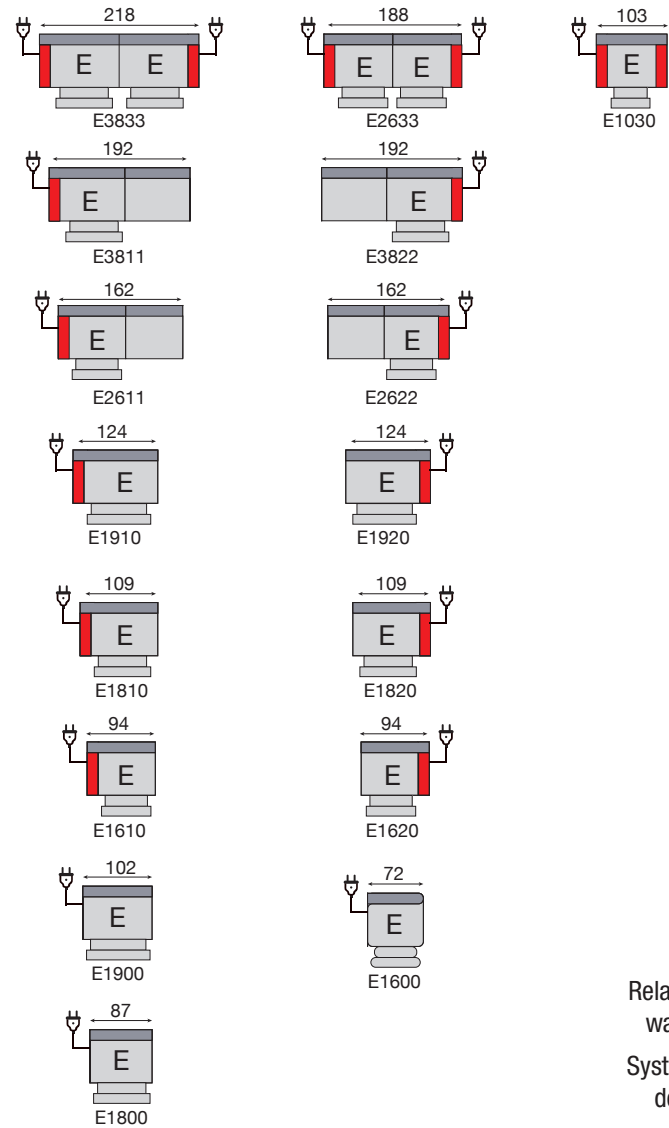

## ADAGIO

Relaxsystem  
wall-away  
Système relax  
dos-mur

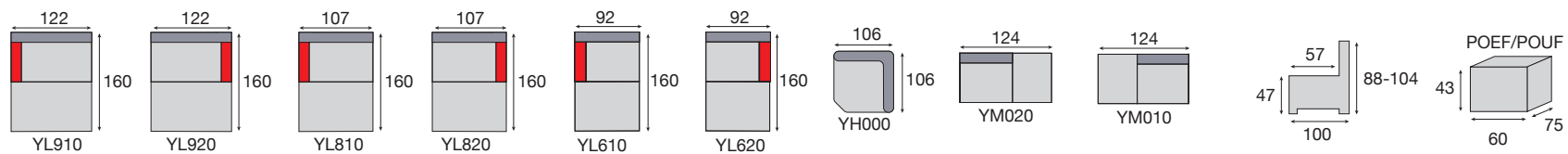



# ADAGIO



E3833+F2630 • Bacif Darkgrey + Bacif Ash

ADAGIO = toon op toon  
= fil ton sur ton

ADAMO = contrasterend garen  
= fil contrasté



185

## VAST/FIXE

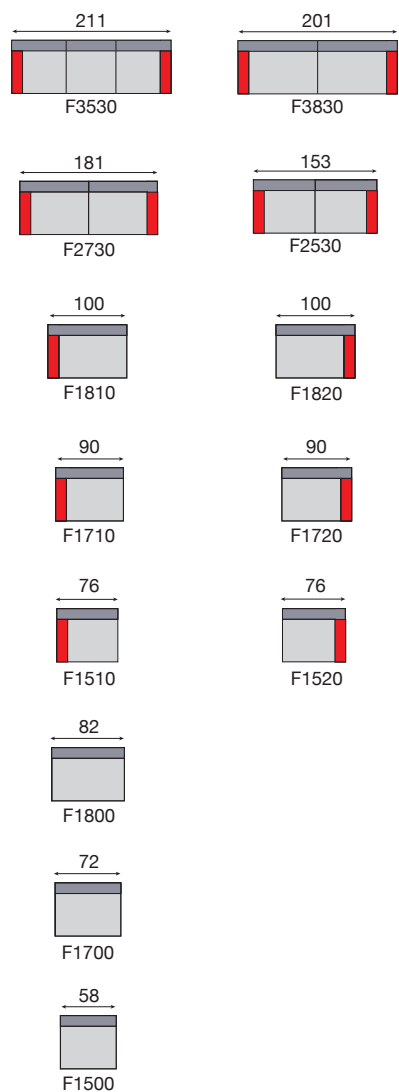

## RELAX MANUEEL/MANUEL

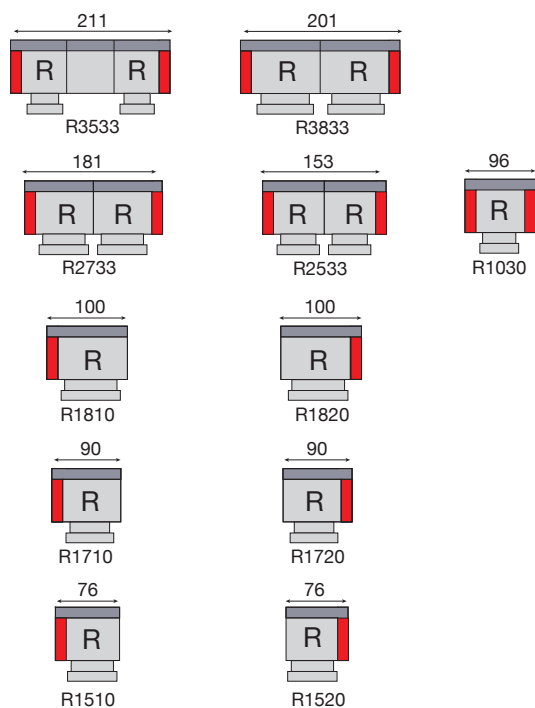

## RELAX ELEKTRISCH/ELECTRIQUE

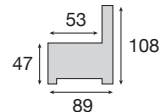
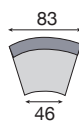
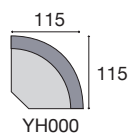
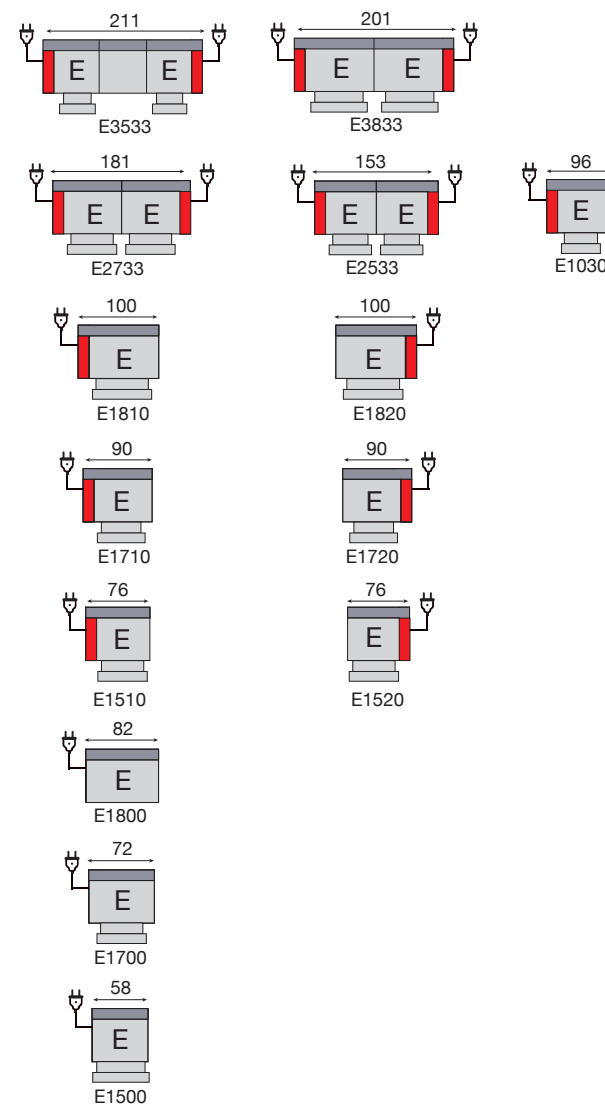

Voorbeeld:  
Exemple:

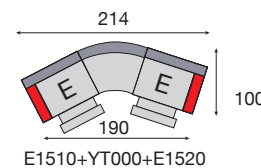

Relaxsystem  
wall-away  
Système relax  
dos-mur

# ALPES



E1510+YT000+E1520+F2530 • Bacif Taupe + Lightgrey

2 x Fan31 Adonis Brown  
2 x Fan30 Alod Oker

ALPES = toon op toon  
= fil ton sur ton

ASTOR = contrasterend garen  
= fil contrasté

187

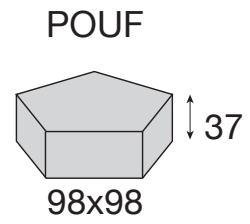
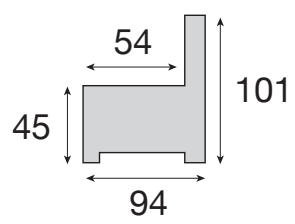
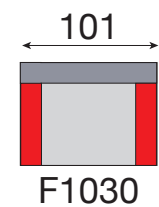
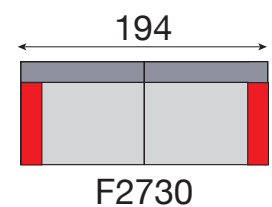
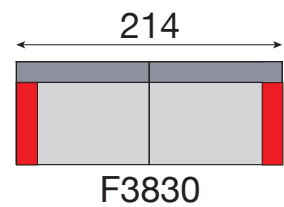
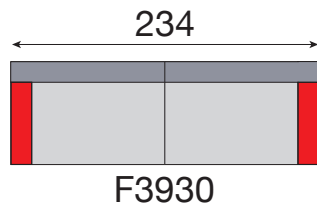

# ANDES



Kleur 1 = massa  
Kleur 2 = bies  
Couleur 1 = masse  
Couleur 2 = passepoile



F3830 • Golf Oker  
F1030 • Golf Hunter  
YP000 • Golf Okter

ANDES = toon op toon  
= fil ton sur ton

189

EXCLUSIVE

## VAST/FIXE



## RELAX ELEKTRISCH/ELECTRIQUE

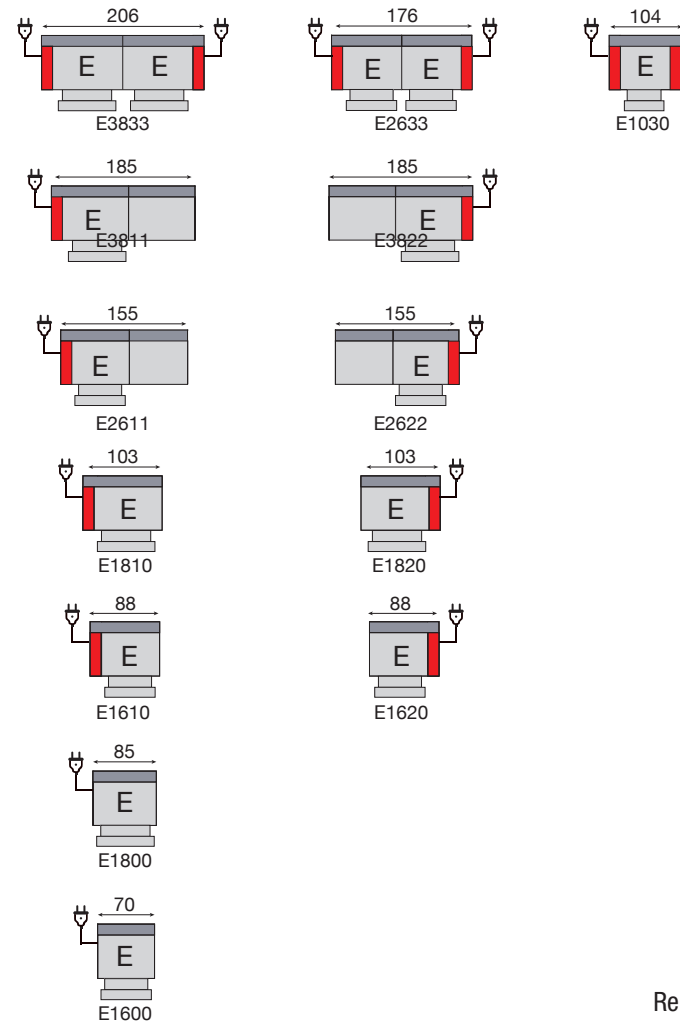

Relaxsystem  
wall-away  
Système relax  
dos-mur

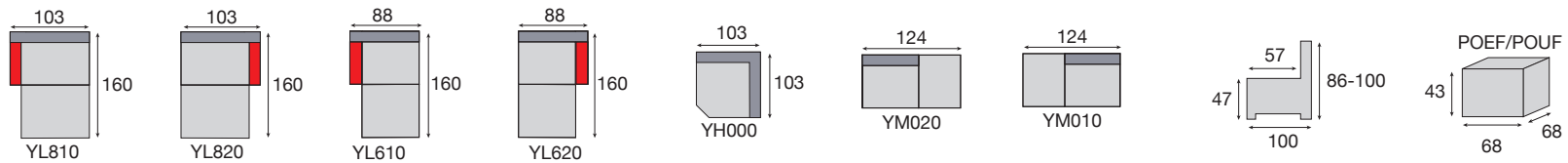

# ANDREAS



E3833+F2630 • Bontan Antraciet + Grey  
1 x Fan31 Berib Grey

ANDREAS = contrasterend garen  
= fil contrasté

ADRIAAN = contrasterend garen  
= fil contrasté

191

YP3800



207 x 108 x 41

YP1000



87 x 108 x 41



YR000



YR100





# AZUMA

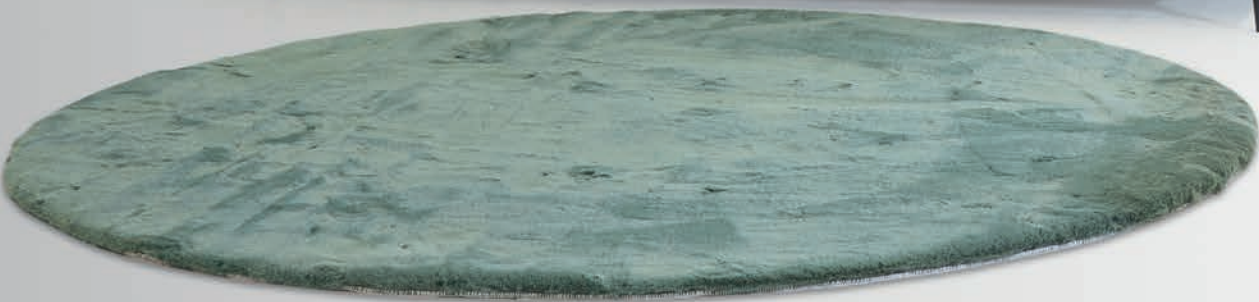

YP3800 • Golf Oker  
YP1000 • Golf Hunter  
3 x YR000 • Golf Hunter

AZUMA = toon op toon  
= fil ton sur ton

# BIBONA

Mogelijk in verschillende materialen en kleuren

Kleur 1 = massa

Kleur 2 = bias (detail)

Couleur 1 = masse

Couleur 2 = passepoile (detail)



YL900

YH000

F1700



E1900

YP900

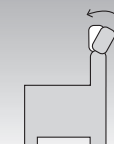

manuele hoofdsteunen  
têtières manuelles

F1700



F1900



E1700

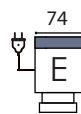

E1900

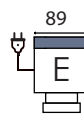

YL700

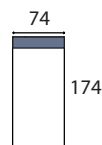

YL900

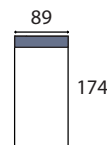

YP700



YP900



YH000

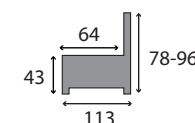
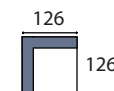

# BIBONA



F1700 Beak Naturel  
F1700 Bador Ecrú  
YH000 Storza Sand

F1900 Barly Almond  
E1900 Beak Naturel  
YL900 Storza Sand

BIBONA = toon op toon  
= fil ton sur ton

195

EXCLUSIVE

## VAST/FIXE

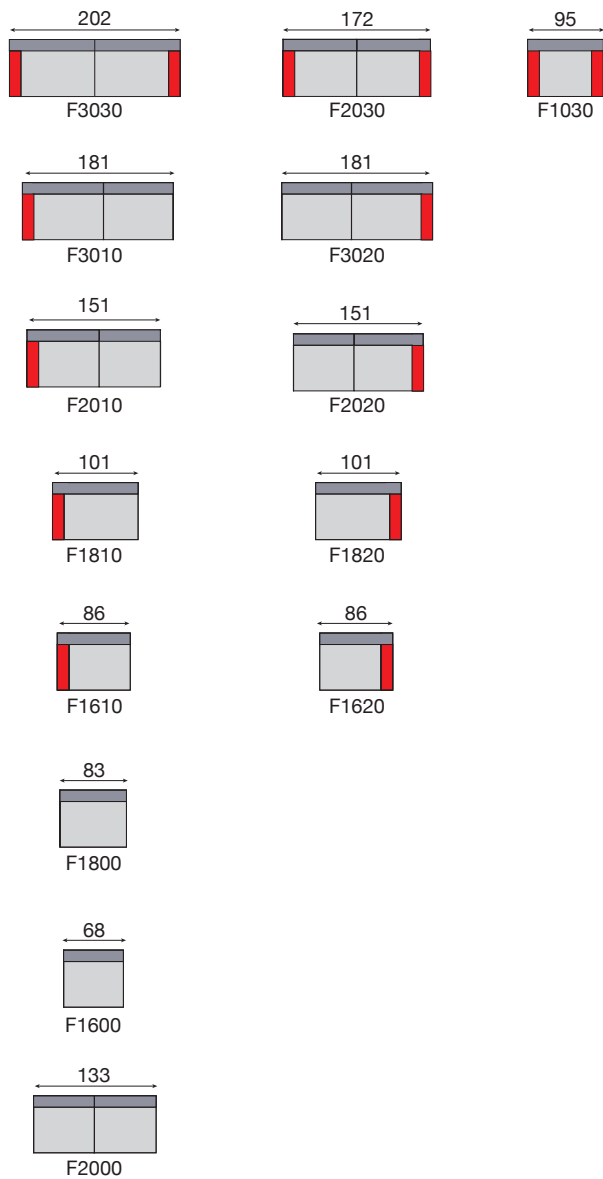

## RELAX ELEKTRISCH/ELECTRIQUE

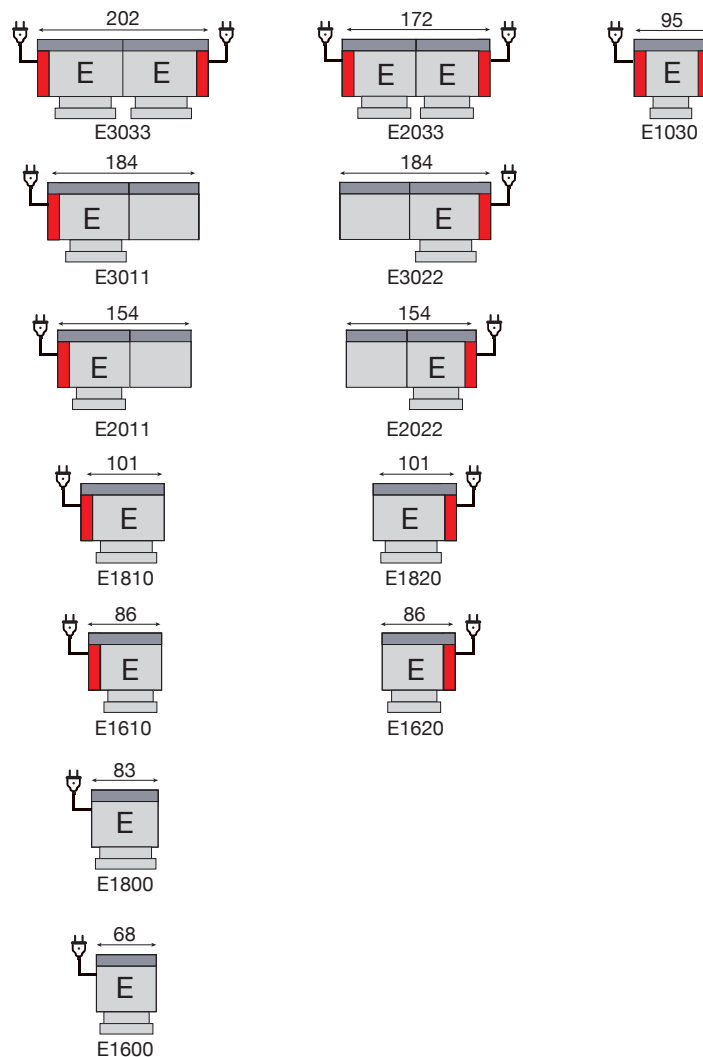

## CALDAS

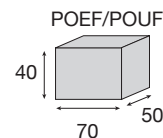
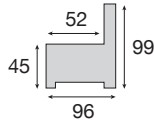
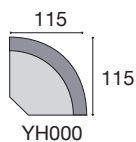

Relaxsystem  
wall-away  
Système relax  
dos-mur

# CALDAS



E3033+F2030 • Bacif Taupe + Bacif Lightgrey  
Fan31 Aris Argil

CALDAS = toon op toon  
= fil ton sur ton

CLUEDO = contrasterend garen  
= fil contrasté

197

## VAST/FIXE



## RELAX ELEKTRISCH/ELECTRIQUE

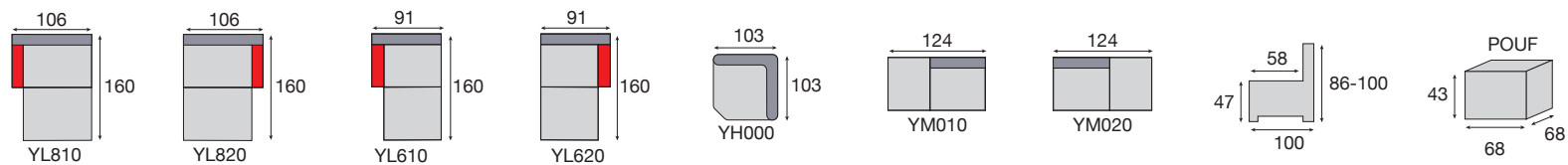
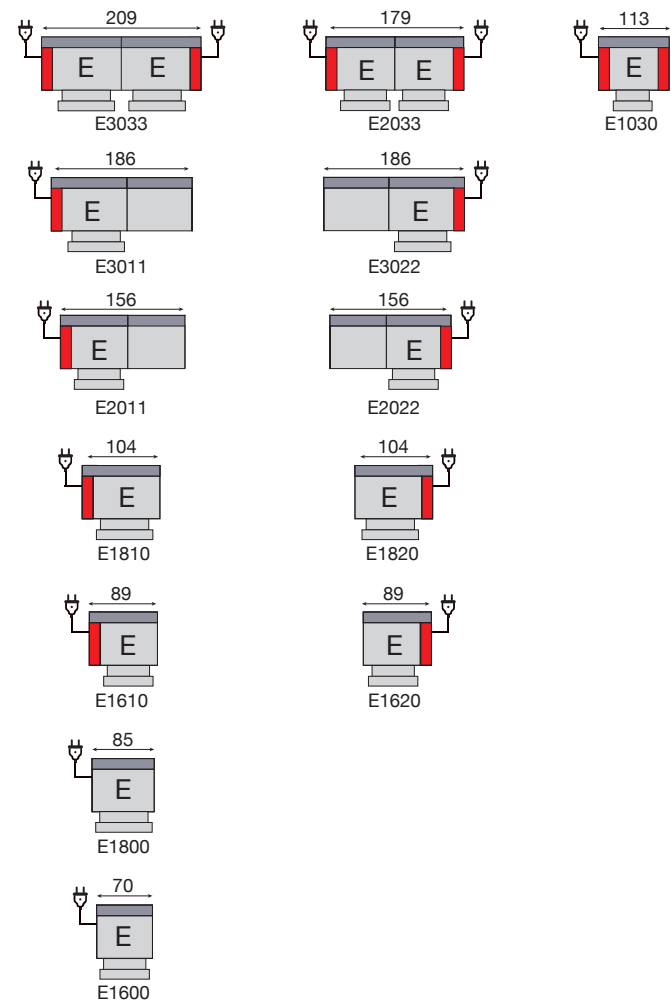

# CELANO



E3033+F2030 • Beskin Silver + Beskin Elephant / CF100  
2 x Fan31 Bador Darkgrey

COLIN = toon op toon  
= fil ton sur ton

CELANO = contrasterend garen  
= fil contrasté

199

VAST/FIXE

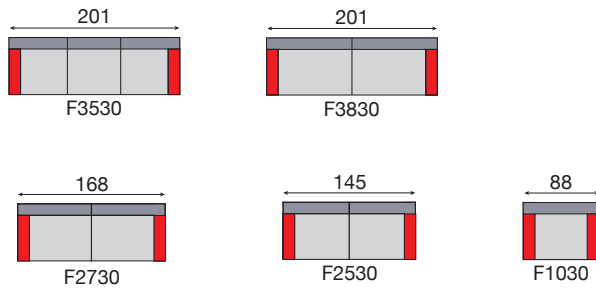

RELAX ELEKTRISCH/ELECTRIQUE

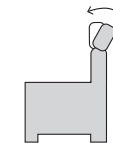
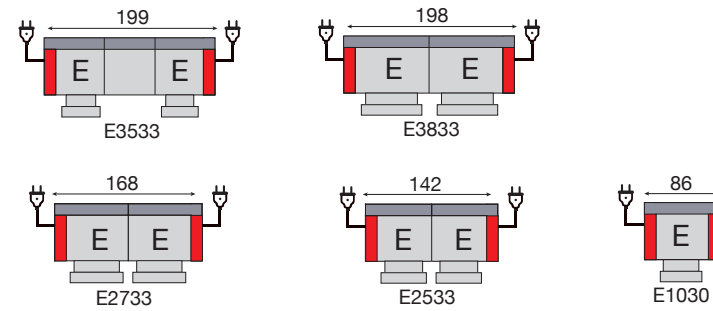

enkel in relax versie  
uniquement  
en version relax



# CHIVOR



E3533+F2530 • Bacif Black + Bacif Ash

CORRY = toon op toon  
= fil ton sur ton

CHIVOR = contrasterend garen  
= fil contrasté



201

## VAST/FIXE



## RELAX ELEKTRISCH/ELECTRIQUE

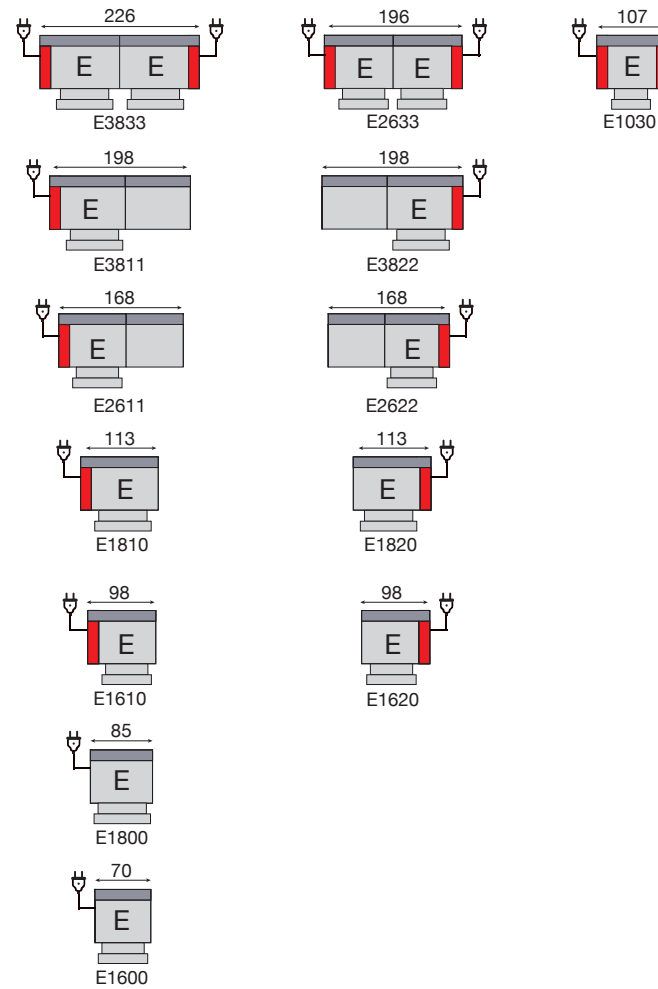

Relaxsystem  
wall-away  
Système relax  
dos-mur

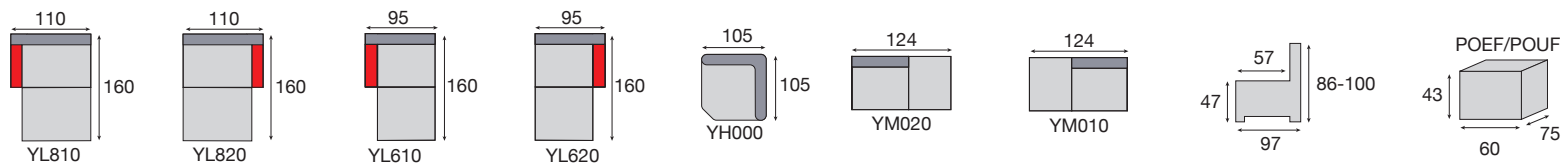

# CODAN



E3833+F2630 • Crutus Sky + Berib Watergreen/CF100

2 x Fan31 Berib Watergreen  
2 x Fan30 Berib Ocean

CODAN = toon op toon  
= fil ton sur ton

CANYON = contrasterend garen  
= fil contrasté



203

## VAST/FIXE

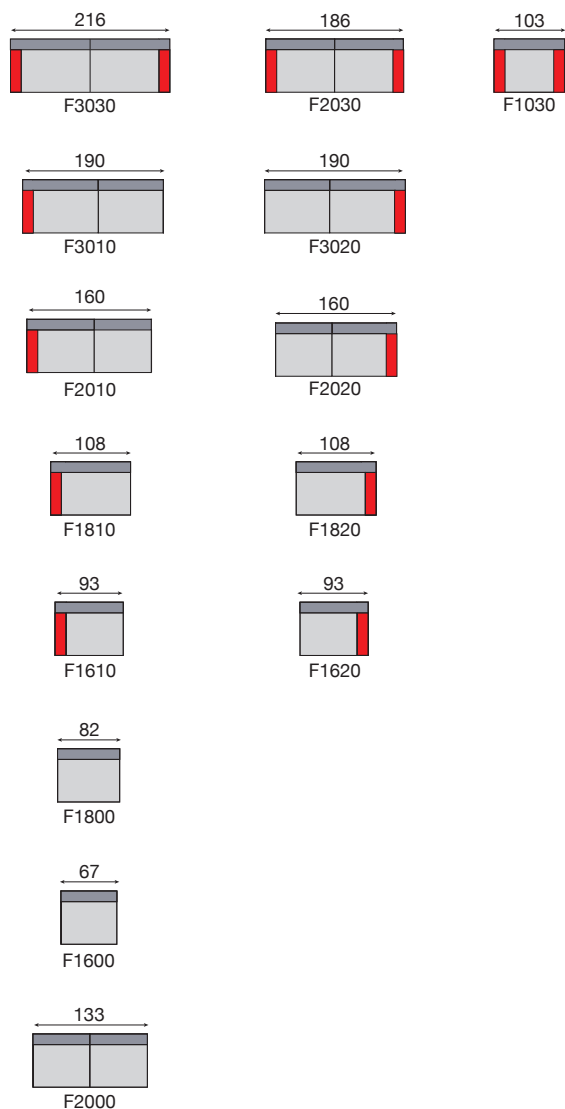

## RELAX ELEKTRISCH/ELECTRIQUE

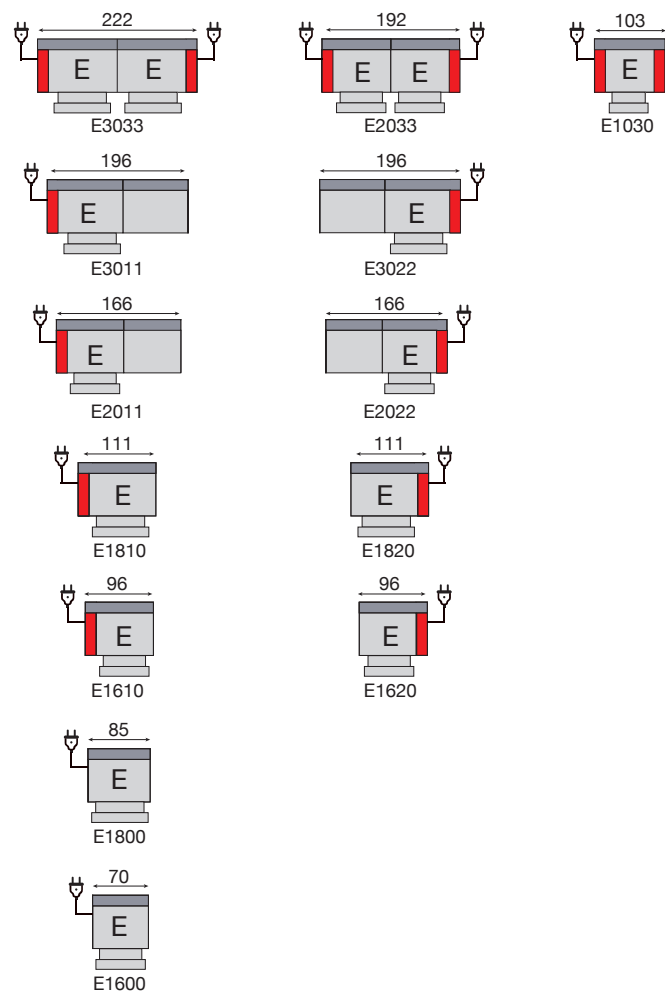

Relaxsystem  
wall-away  
Système relax  
dos-mur

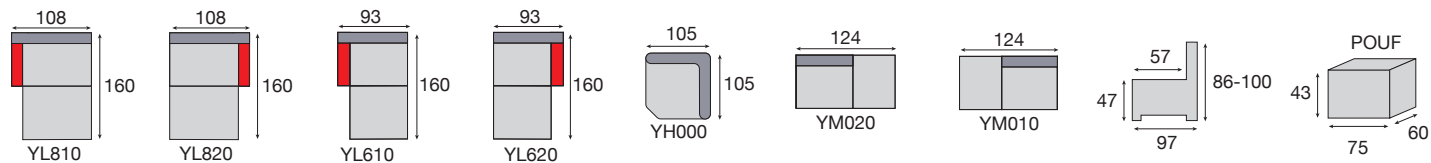

# COME



CALINE Club  
Crutus Ocean + Sky



Bob Poef  
Crutus Sky



E3011+YH000+YM020 • Crutus Sky + Ocean/CF100  
2 x Fan30 Bost Ocean / Fan31 Crutus Sky

COME = toon op toon  
= fil ton sur ton  
CONDOR = contrasterend garen  
= fil contrasté

205

MOGELIJK IN VERSCHILLENDE MATERIALEN EN KLEUREN  
 POSSIBLE EN PLUSIEURS REVÊTEMENTS ET COLORIS



YL1000

YH000

E1000



F1000

YP0000

YP1000

YA1020

YA1010 YA1020 YP0000 YP1000 YH000 F1000 E1000 YL1000

Accoudoir gauche

Accoudoir droite

Pouf carré

Pouf trapeze

21

21

74

93

108

74

74

74

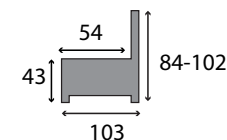
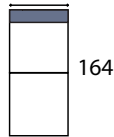
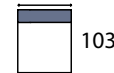
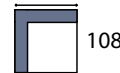
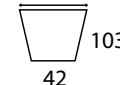
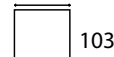

# ELSY

Kleur 1 = romp  
Kleur 2 = zit + rug

Couleur 1 = caisse  
Couleur 2 = assise + dossier



YA1010+YL1000+F1000+E1000+YH000+F1000+YP0000

2 x Fan31 Alod Oker  
2 x Fan30 Adonis Grey  
1 x Fan30 Alod Antraciet

ELSY = toon op toon  
= fil ton sur ton

207

## VAST/FIXE

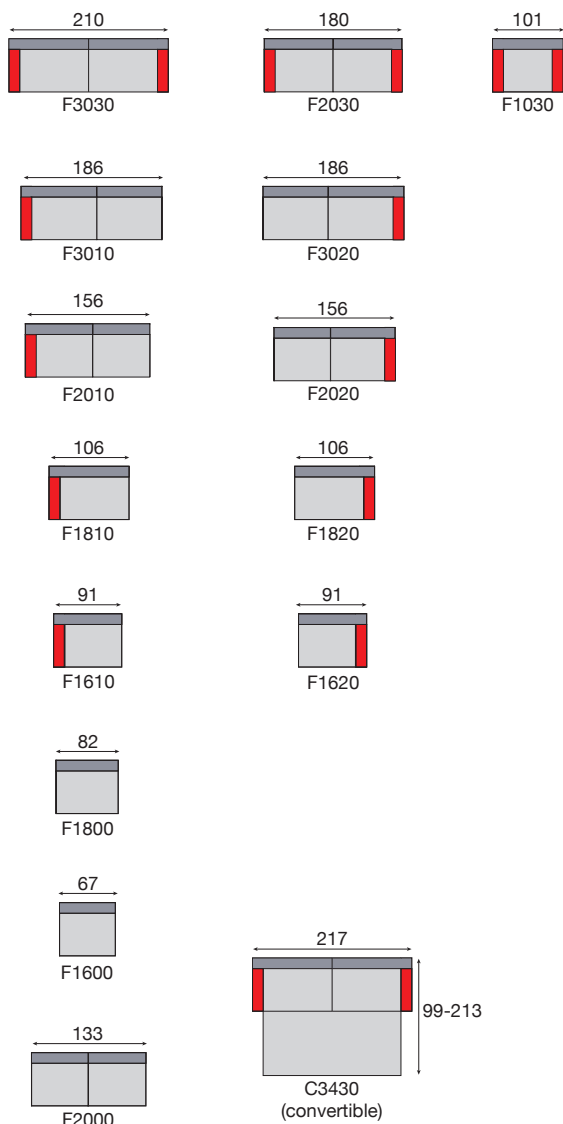

## RELAX ELEKTRISCH/ELECTRIQUE

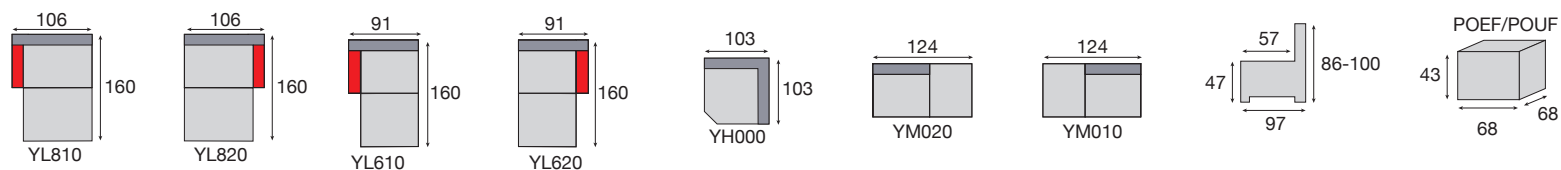
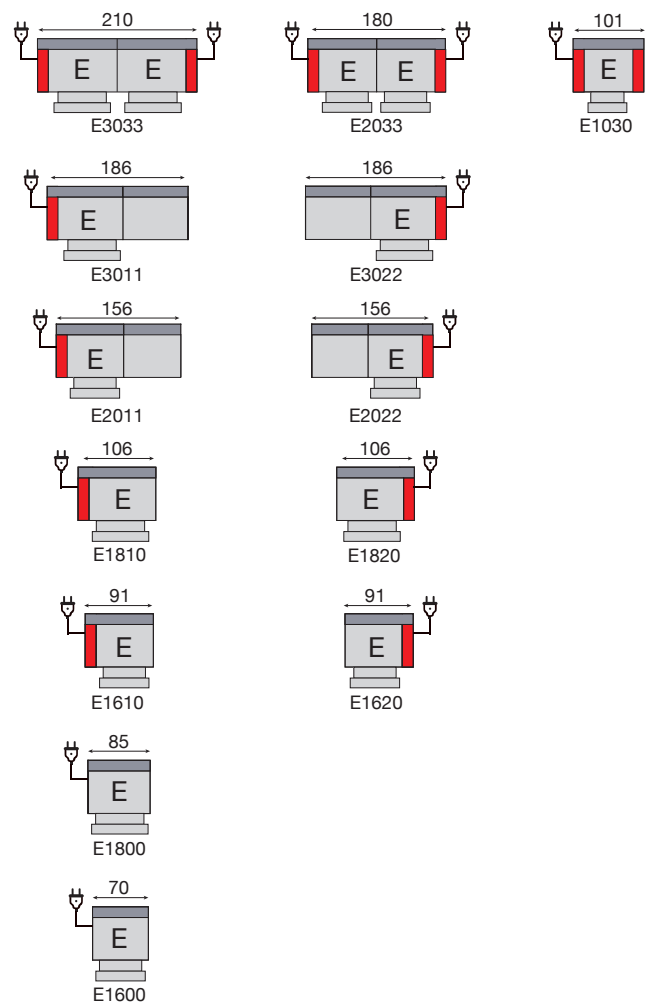



# LORE



YM010+YH000+E1800+E1820  
Belux Antraciet + Papyrus

LIZZY = toon op toon  
= fil ton sur ton

LORE = contrasterend garen  
= fil contrasté



209

## VAST/FIXE

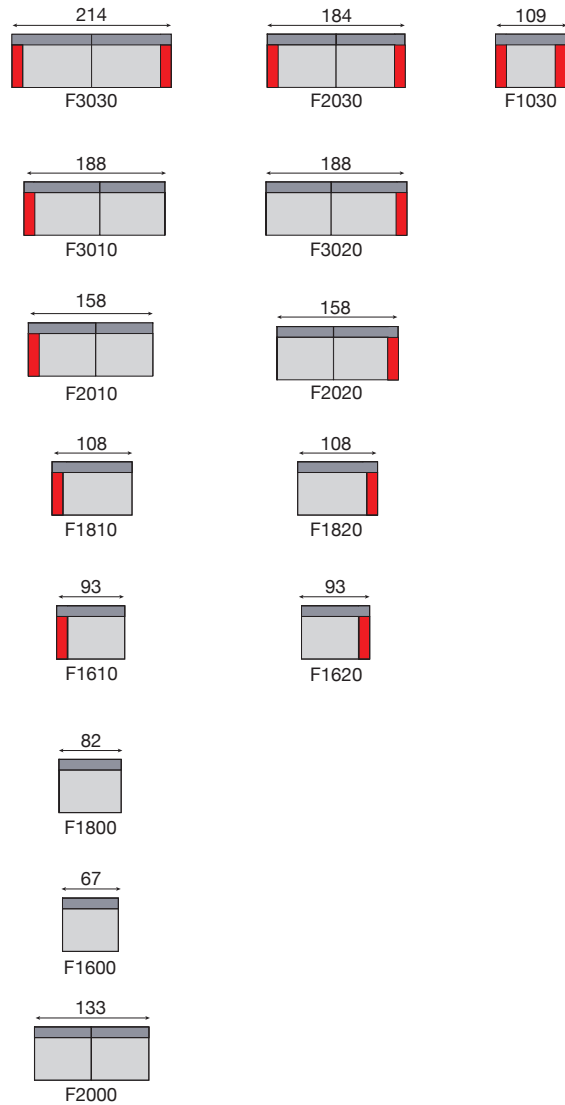

## RELAX ELEKTRISCH/ELECTRIQUE

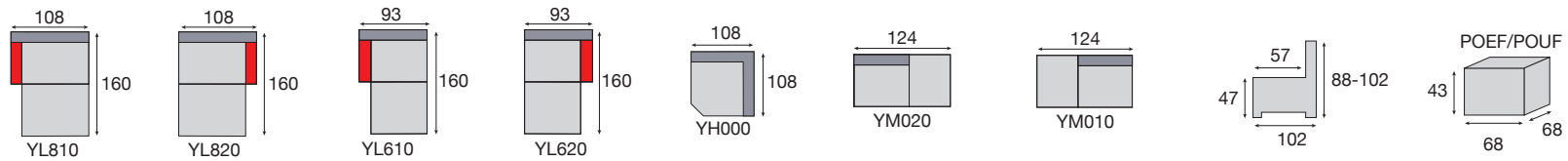
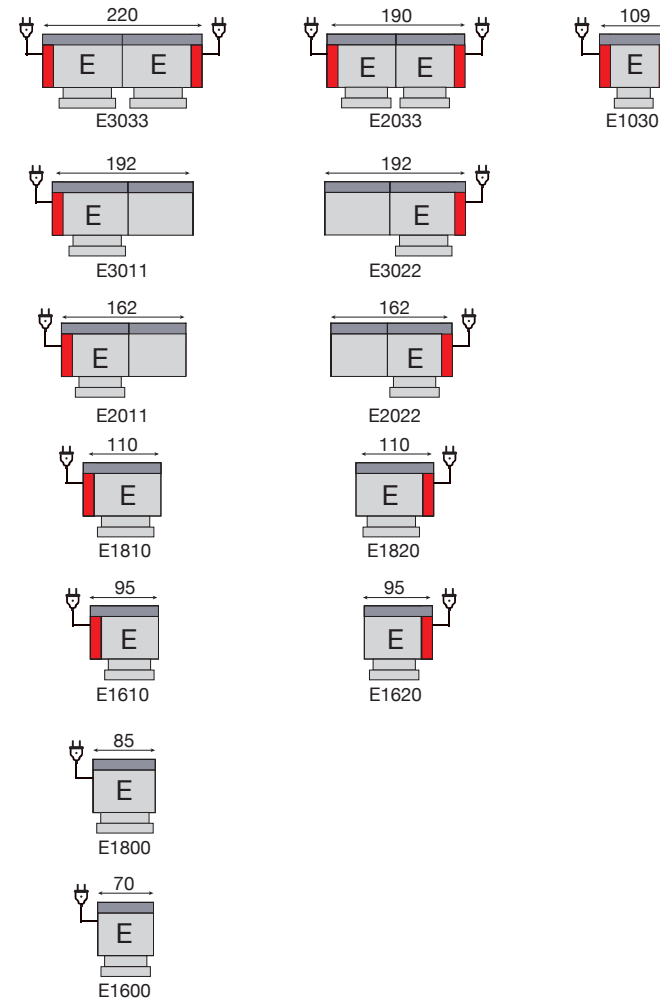

# MANDY



F2030+E2011+YL820 • Bacif Darkgrey + Ash

3 x Fan31 Aris Colombe  
Bob poef: Aris Celadon

MANDY = toon op toon  
= fil ton sur ton

MALLORCA = contrasterend garen  
= fil contrasté

211

VAST/FIXE

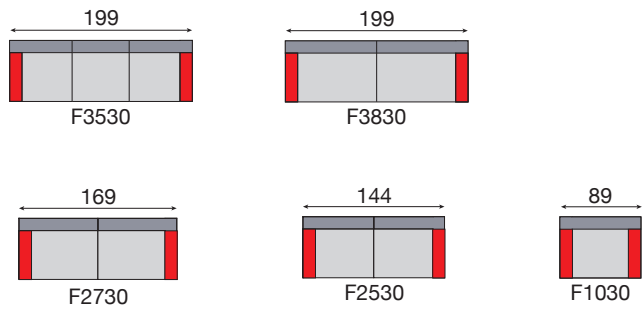

RELAX ELEKTRISCH/ELECTRIQUE

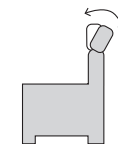
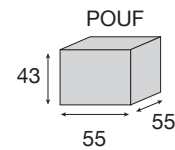
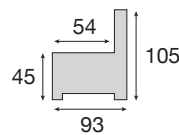
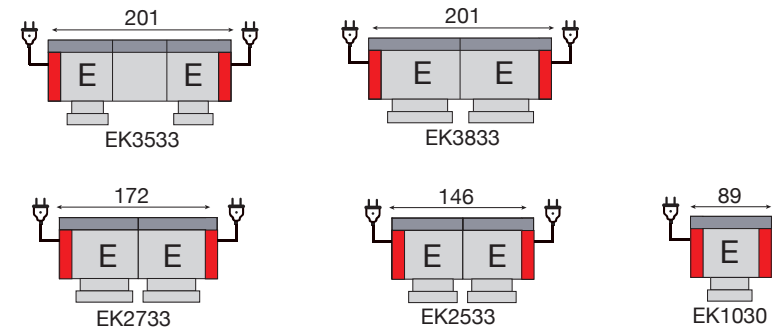

elektrische hoofdsteun  
enkel in relax versie  
tête électrique  
uniquement  
en version relax

# MERLOT



EK1030+EK3533 • Bacif Darkgrey + Ash

MEDOC = toon op toon  
= fil ton sur ton

MERLOT = contrasterend garen  
= fil contrasté

213

## VAST/FIXE

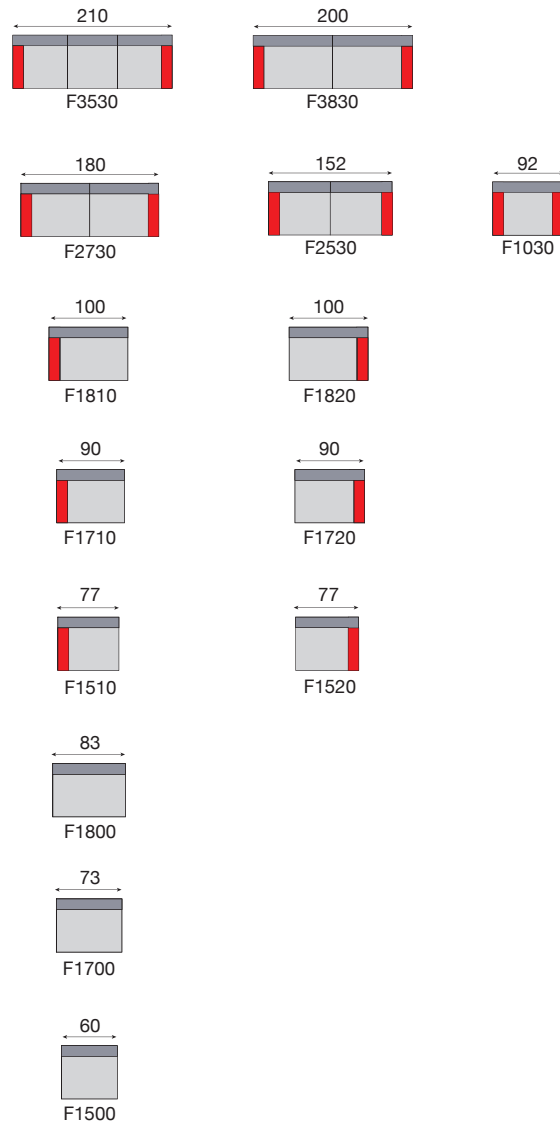

## RELAX MANUEEL/MANUEL

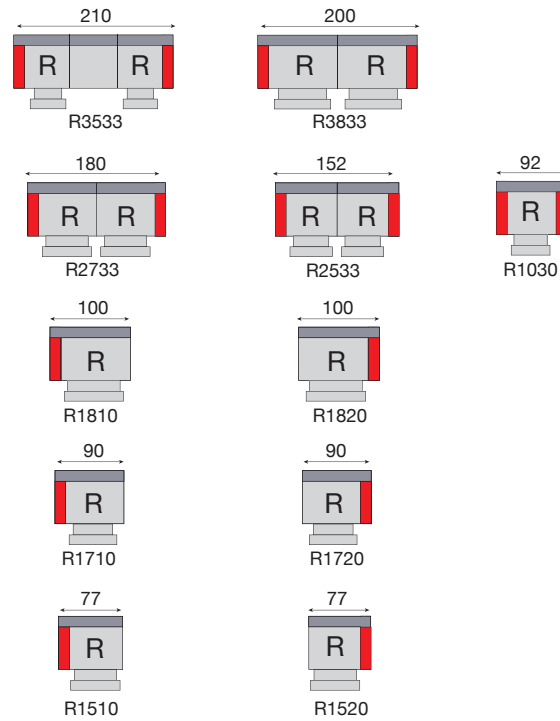

## RELAX ELEKTRISCH/ELECTRIQUE

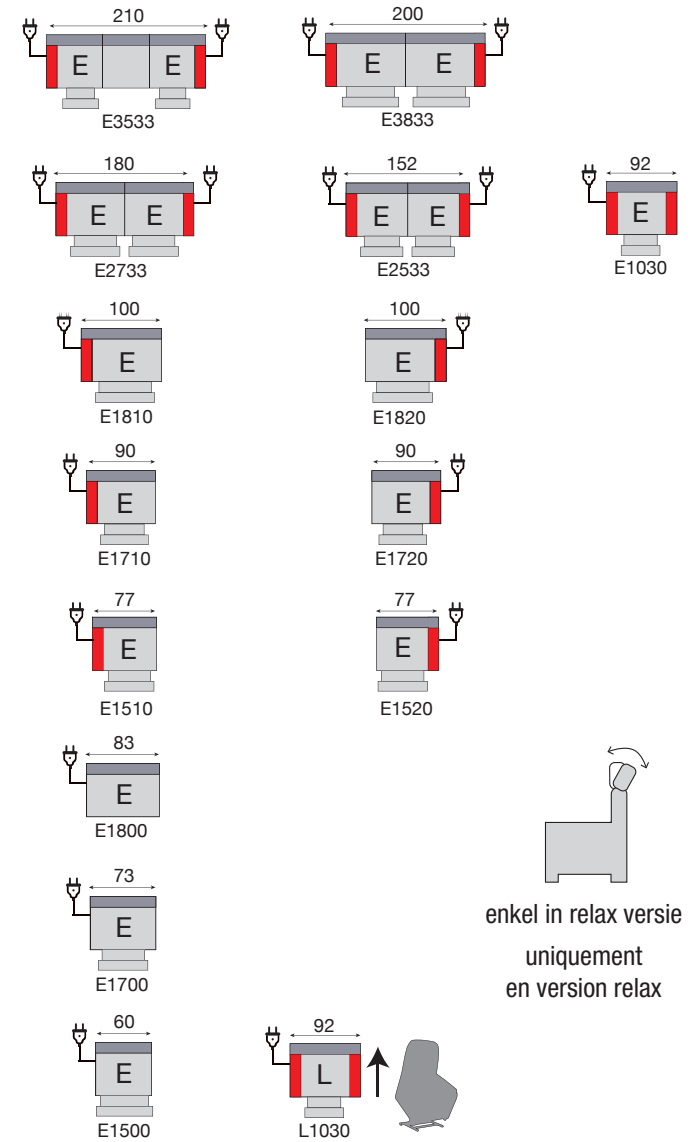

enkel in relax versie  
uniquement  
en version relax

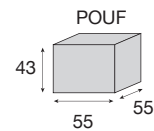
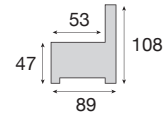
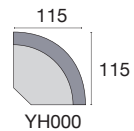

Relaxstelsysteem  
wall-away  
Système relax  
dos-mur

# MODRIC



Jacqueline poef  
Aris Negre

E3533+F2530 • Bacif Mouse + Taupe  
2 x Fan31 Anada Taupe

MIDOU = toon op toon  
= fil ton sur ton

MODRIC = contrasterend garen  
= fil contrasté



215

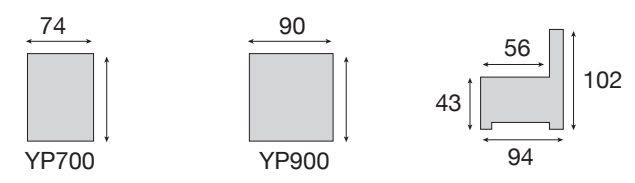
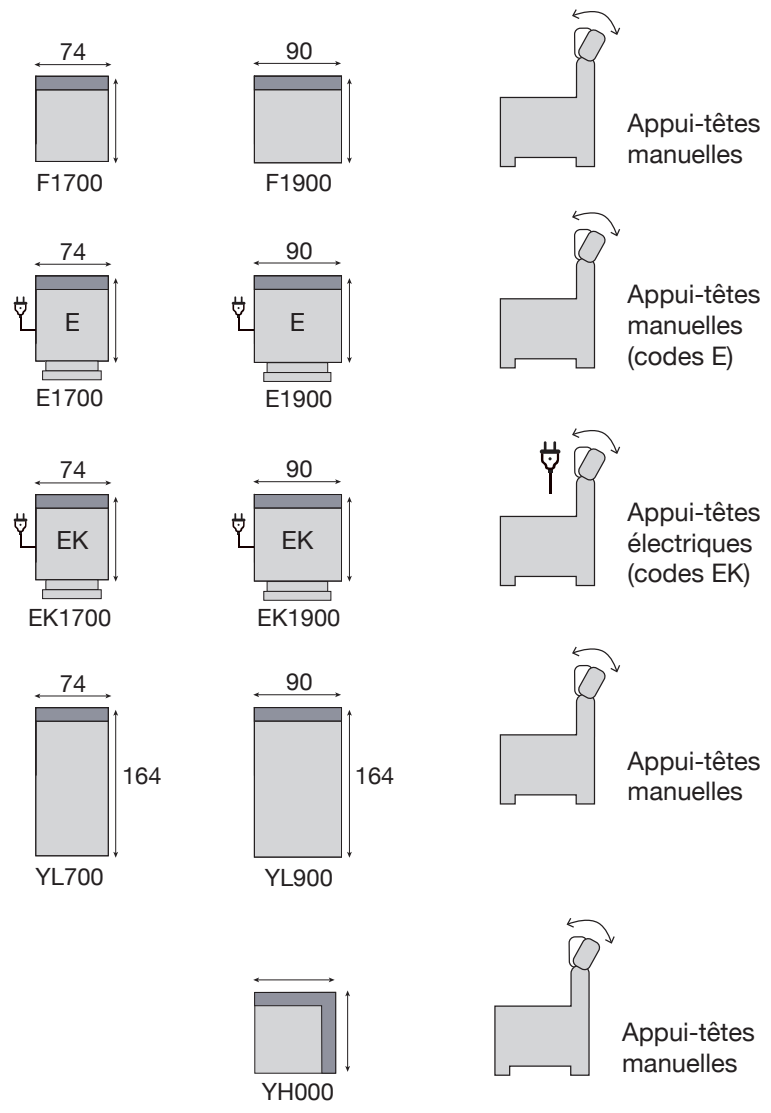



# NOUPORT



Bandy White

Beskin Cream

Dasco Pearl

Bandy White

Beskin Cream

Dasco Pearl

YP900+F1900+YH000+F1900+EK1900+YL900

1 x Fan31 Dasco Pearl

2 x Fan31 Beskin Cream

NOUPORT = toon op toon  
= fil ton sur ton

217

EXCLUSIVE

## VAST/FIXE



## RELAX ELEKTRISCH/ELECTRIQUE

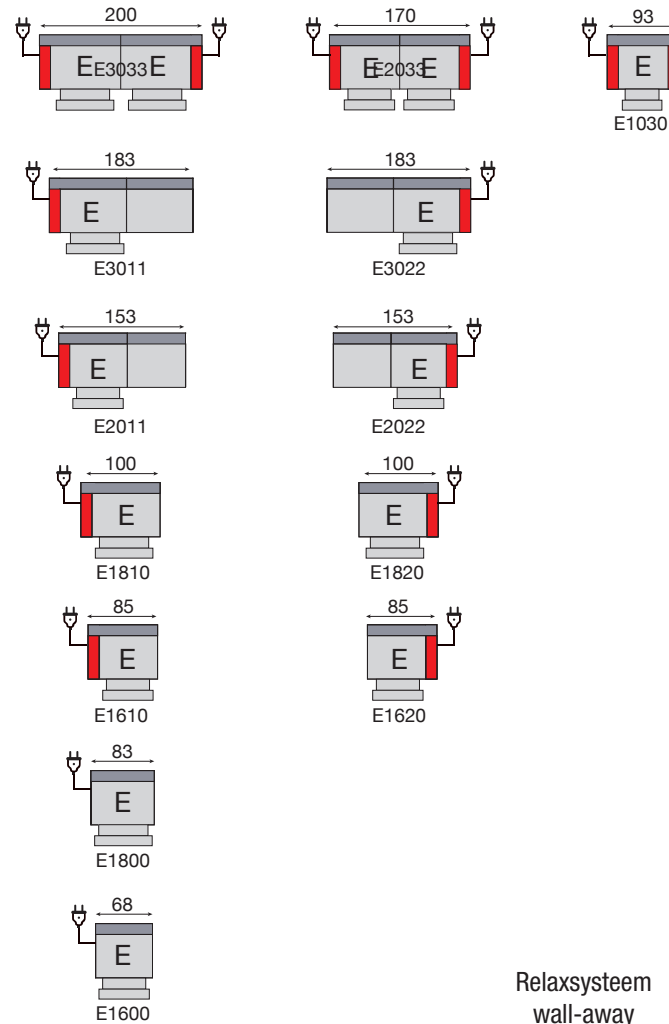

Relaxsystem  
wall-away  
Système relax  
dos-mur

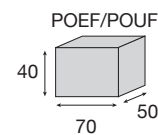
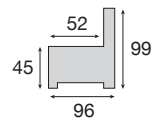
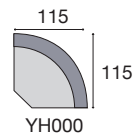

# ORTONA



CALINE Club  
Santo Carafe + Bepal Darkgrey

2 x Bobette  
Bepal Darkgrey

E3833+F2630  
Santo Carafe + Bepal Darkgrey

ORTONA = toon op toon  
= fil ton sur ton

OMODA = contrasterend garen  
= fil contrasté

219

## VAST/FIXE



## RELAX ELEKTRISCH/ELECTRIQUE

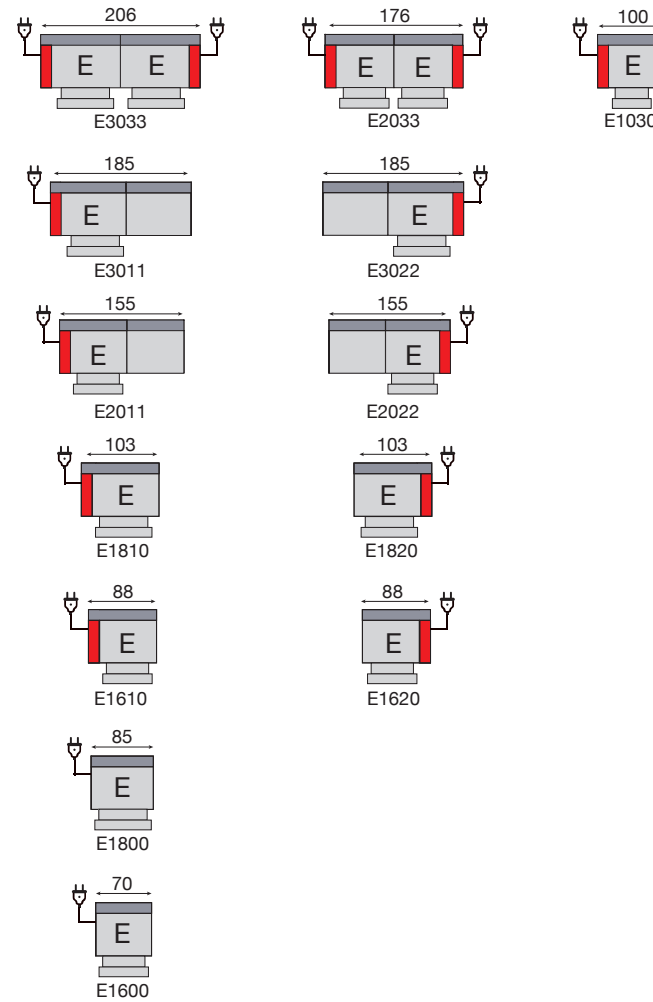

Relaxsystem  
wall-away  
Système relax  
dos-mur

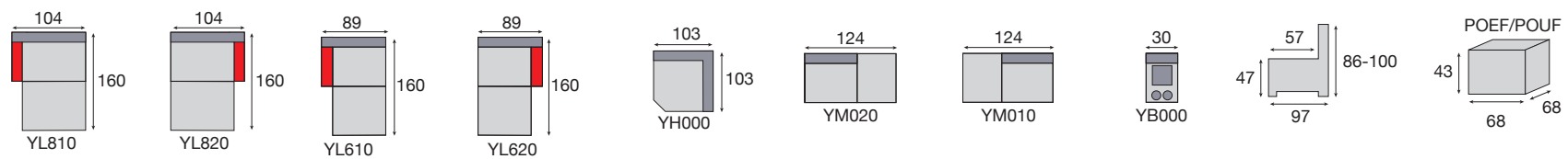

# PANENKA



F2030+E1810+YB000+E1820  
Belux Grey + Belux Steel

PANENKA = toon op toon  
= fil ton sur ton

PANAMERA = contrasterend garen  
= fil contrasté

221

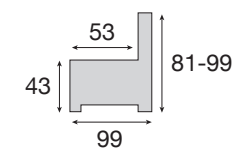
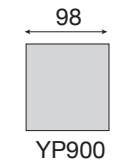
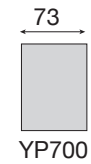
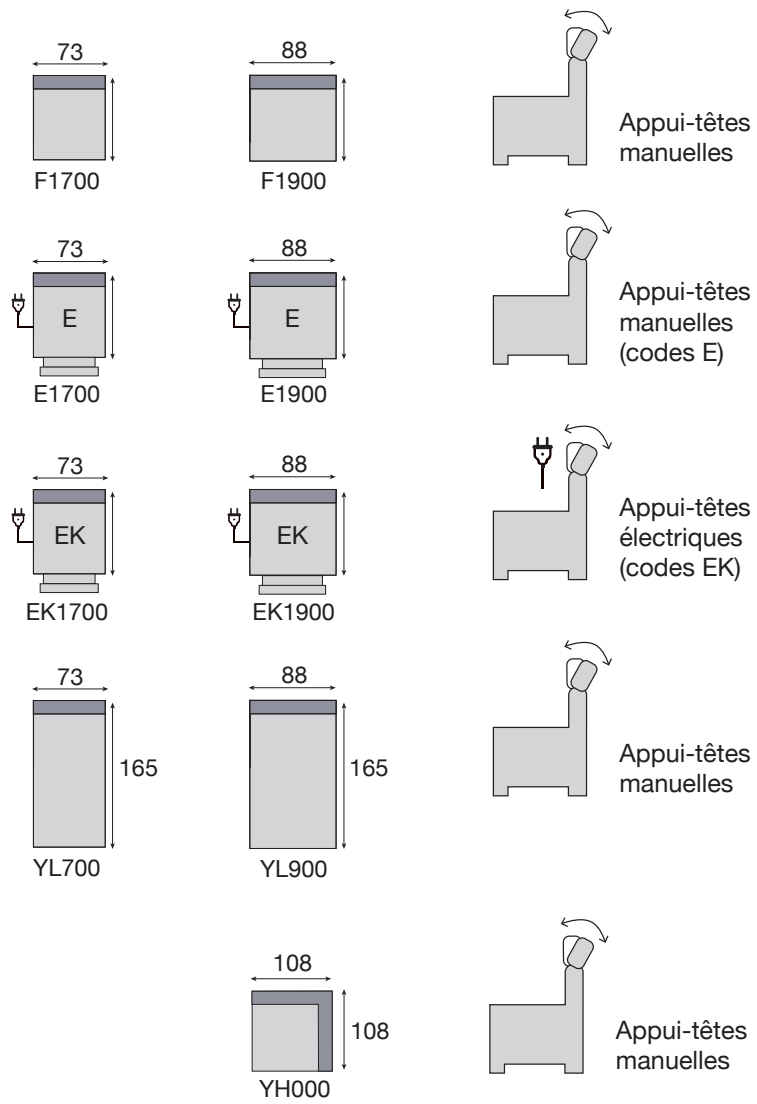

# ROSARO



Barmon Mustard

Barmon Coconut

Barmon Mustard

Barmon Coconut

Barmon Mustard

Barmon Coconut

YP700+F1700+YH000+F1900+EK1900+YL900

ROSARO = toon op toon  
= fil ton sur ton

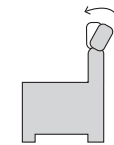
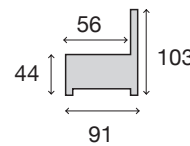
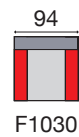
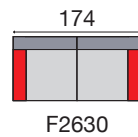
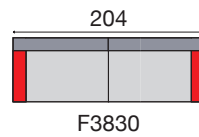
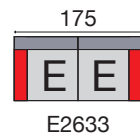
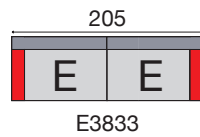

enkel in relax versie  
uniquement  
en version relax

Relaxstelsysteem  
wall-away  
Système relax  
dos-mur



# SANDY



CALI Club  
Bacif Ash + Catri Moss

E3833+F2630 • Bacif Ash + Mouse  
2 x Fan31 Catri Moss

SYNTRO = toon op toon  
= fil ton sur ton

SANDY = contrasterend garen  
= fil contrasté



225

MOGELIJK IN VERSCHILLENDE MATERIALEN EN KLEUREN  
 POSSIBLE EN PLUSIEURS REVÊTEMENTS ET COLORIS



YL1000

YH000

YP2000



F1000

E1000

YP0000

YP0000

YP2000

YH000

F1000

E1000

YL1000

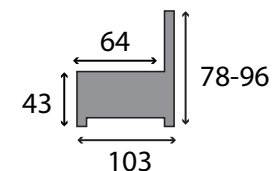
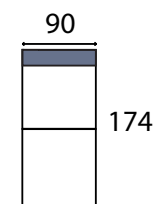
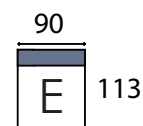
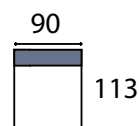
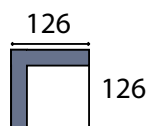
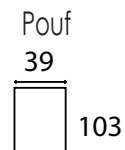
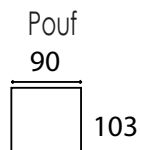

Relaxsystem  
 wall-away  
 Système relax  
 dos-mur

# SERPA



YL1000+F1000+E1000+H000+F1000+YP000

Fan31 Boxfor Aubergine/Boxfor Pink  
Fan35 Boxfor Grey/Boxfor Aubergine

SERPA = toon op toon garen  
= fil ton sur ton

SOTSJI = contrasterend garen  
= fil contrasté

227

## VAST/FIXE



## RELAX ELEKTRISCH/ELECTRIQUE

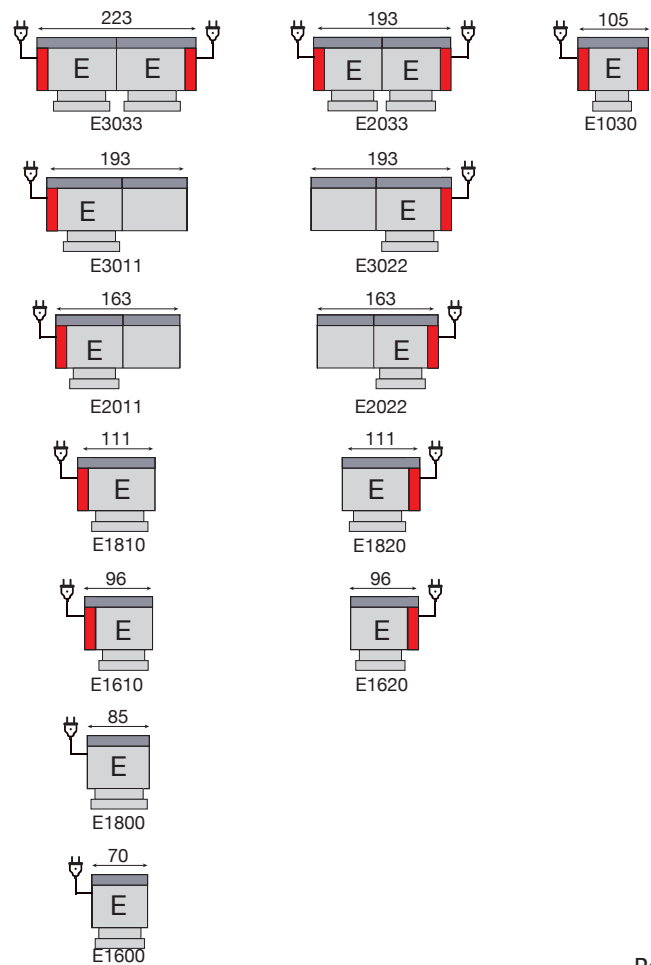

Relaxsystem  
wall-away  
Système relax  
dos-mur

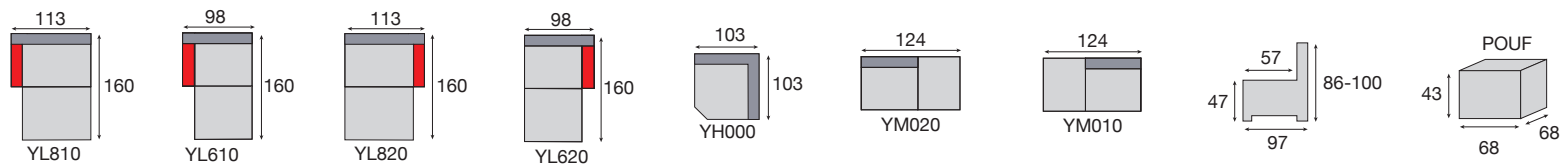

# THEO



E1810+E1800+YH000+YM020  
Bacif Darkgrey + Lightgrey

THARA = toon op toon  
= fil ton sur ton

THEO = contrasterend garen  
= fil contrasté

229

# THEO



Afmetingen zie p. 228  
Dimensions p. 228

E3033+F2030/Chroom  
Barillo Antraciet + Silver

230

THARA = toon op toon  
= fil ton sur ton

THEO = contrasterend garen  
= fil contrasté

# THEO



Afmetingen zie p. 228  
Dimensions p. 228

C3430  
Barillo Antraciet + Silver

## UMITI

Kleur 1 = romp  
 Kleur 2 = kussens  
 Kleur 3 = bias

Couleur 1 = caisse  
 Couleur 2 = coussins  
 Couleur 3 = passepoile

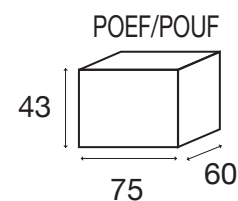
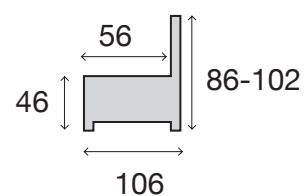
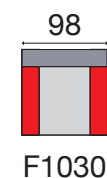
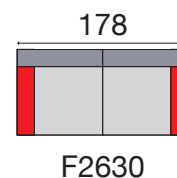
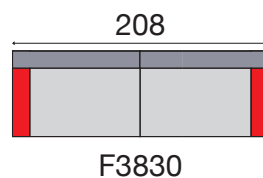
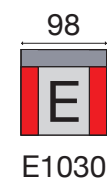
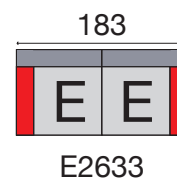
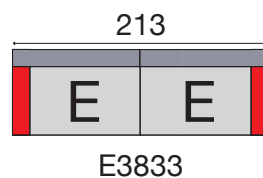

Relaxsystem  
 wall-away  
 Système relax  
 dos-mur



# UMITI



E3833+F2630 • Crutus Mostara + Colo Yellow + Bost Lightgrey

2 x Fan31 Bost Lightgrey

1 x Fan31 Colo Yellow



UTOYA = toon op toon  
= fil ton sur ton

UMITI = contrasterend garen  
= fil contrasté

233

BOUW UW SALON VOLLEDIG NAAR EIGEN KEUZE  
 COMPOSEZ VOTRE SALON A VOLONTE

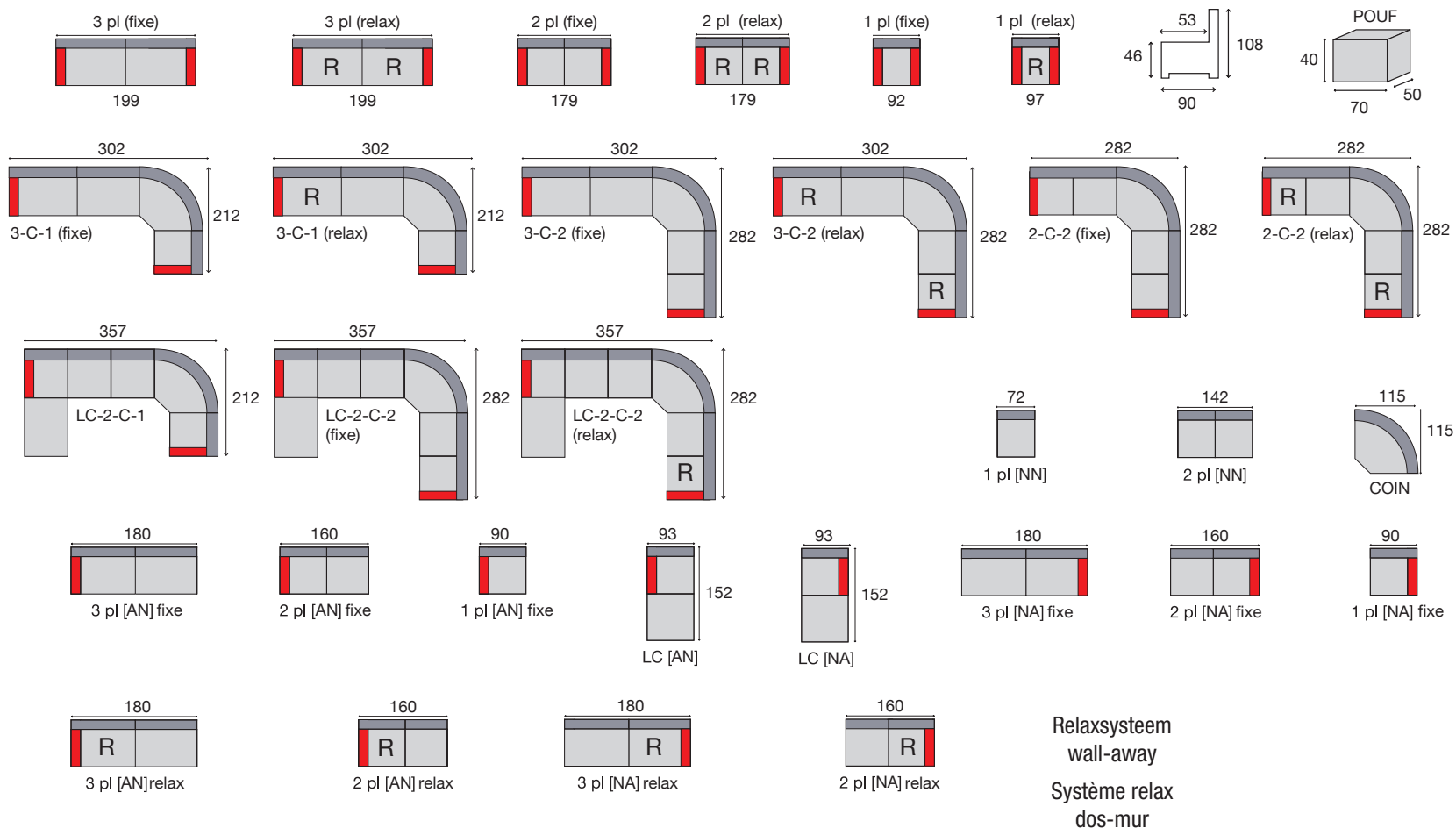

# WILSON



3+2 (2rlx electr.) • Crutus Darkbrown + Lightgrey

WILSON = toon op toon  
= fil ton sur ton

WILLY = contrasterend garen  
= fil contrasté

235

# ACCESSORIES

**BOB  
JACQUES**

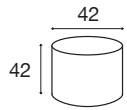

**BOBETTE  
JACQUELINE**

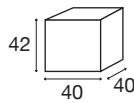

**BARBI**

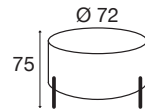

**GERARD/GERALDINE  
Bontan Elephant**



**SANDER/SANDRINE  
Bacif Ash**

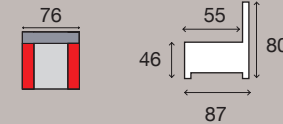

**BOB/BOBETTE/BARBI** = toon op toon  
= fil ton sur ton

**JACQUES/JACQUELINE** = contrasterend garen  
= fil contrasté

**GERALDINE/SANDRINE** = toon op toon  
= fil ton sur ton

**GERARD/SANDER** = contrasterend garen  
= fil contrasté

**GERARD/GERALDINE  
Beskin Silver + Beskin Elephant**



**SANDER/SANDRINE  
Barillo Darkgrey + Silver**



# ACCESSORIES

## BASSO/BALOR

BOST FOREST CF100

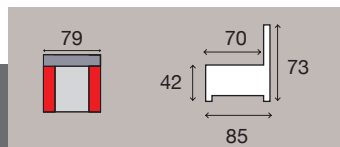

**BALOR** = contrasterend garen  
= fil contrasté

**BASSO** = toon op toon  
= fil ton sur ton

## CALI

BADOR BEIGE + GOLD

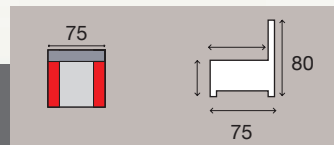

**CALI** = contrasterend garen  
= fil contrasté

**CALINE** = toon op toon  
= fil ton sur ton

## IKER

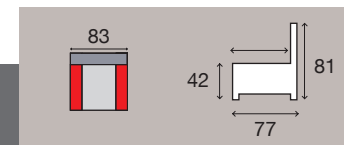

**IKER** = toon op toon  
= fil ton sur ton

Kleur 1 = massa  
Kleur 2 = achterrug

Couleur 1 = masse  
Couleur 2 = dossier arrière

# ACCESSORIES

ITALY

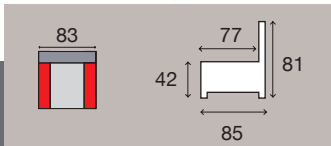

NORDIK

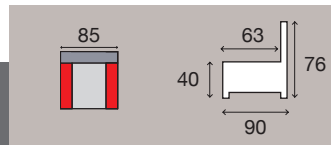

PIRAS

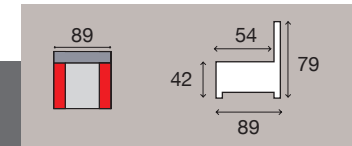

**IRLAND** = contrasterend garen  
= fil contrasté

**ITALY** = toon op toon  
= fil ton sur ton

Kleur 1 = massa  
Kleur 2 = rugkussen

238  
Couleur 1 = masse  
Couleur 2 = coussin d'assise

**NOLF** = contrasterend garen  
= fil contrasté

**NORDIC** = toon op toon  
= fil ton sur ton

Kleur 1 = onderstel  
Kleur 2 = bovenstel

Couleur 1 = base  
Couleur 2 = masse

**PIRAS** = toon op toon  
= fil ton sur ton

Kleur 1 = massa  
Kleur 2 = rugkussen

Couleur 1 = masse  
Couleur 2 = coussin d'assise

# ACCESSORIES

PLUMI/PLUTO

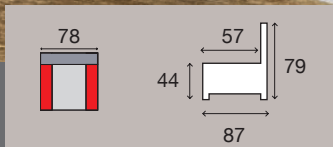

**PLUTO** = contrasterend garen  
= fil contrasté

**PLUMI** = toon op toon  
= fil ton sur ton

TAMBER

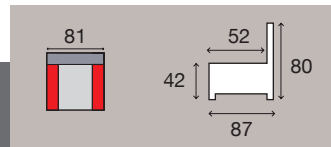

**TAMBER** = toon op toon  
= fil ton sur ton

Kleur 1 = romp  
Kleur 2 = zit+rug

Couleur 1 = caisse  
Couleur 2 = assise+dossier

TAMPICO

BEPAL OCEAN + SANTA OCEAN

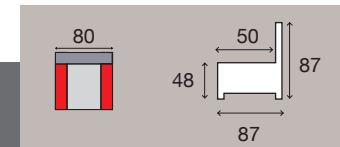

**TAMPERE** = contrasterend garen  
= fil contrasté

**TAMPICO** = toon op toon  
= fil ton sur ton

Kleur 1 = romp  
Kleur 2 = zit+rug

Couleur 1 = caisse  
Couleur 2 = assise+dossier

# ACCESSORIES

## LAZE



### 1 ONDERSTEL / BASE

 Cirkel / Cercle



 Ster / Etoile



### 2 KLEUR / COULEUR

 Chroom / Chrome

 Zwart / Noir

### 3 FORMAAT / TAILLE

 Small

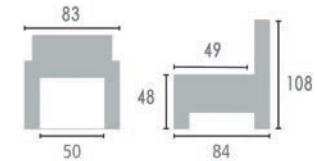

 Medium

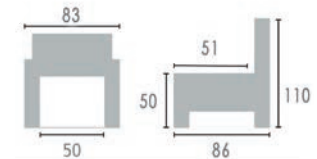

 Large

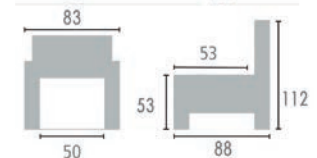

### 4 BEWEGING / MOUVEMENTS

 Manuele relax  
Relax manuel



 Dubbele motor  
Double moteur



 Driedubbele motor  
Triple moteur





# ACCESSORIES

FAN 1/2/14



FAN 31



FAN 10



FAN 35



FAN 23



FAN 60



FAN 30



FAN 130



- FAN 1 : 55 x 55 cm
- FAN 2 : 35 x 35 cm
- FAN 10 : 46 x 46 cm
- FAN 14 : 46 x 46 cm
- FAN 23 : 50 x 50 cm
- FAN 30 : 35 x 35 cm
- FAN 31 : 45 x 45 cm
- FAN 35 : 25 x 65 cm
- FAN 60 : 55 x 38 cm
- FAN 130 : 50 x Ø17 cm



Makeveldstraat 7A | B-8610 Kortemark

T +32 (0)51 567 901

F +32 (0)51 567 476

[sales@hima.be](mailto:sales@hima.be)